

Offering a choice of as many as 14 models for gauge,  
absolute and differential pressures.

High Accuracy

Series of Digital Manometers

# MT210/MT210F



- High accuracy:  $\pm 0.01\%$ , with a maximum allowable input of 500 kPa (130 kPa-range model)
- A wide range of pressures, from a low differential pressure of 1 kPa to a high gauge pressure of 3000 kPa
- Select from three measurement modes: normal speed, medium speed, and high speed (MT210F series)
- D/A conversion output, comparator output, and external trigger input (optional)
- GP-IB and RS-232 interfaces ● 12-V DC power supply ● Battery operation (optional)

**Best suited for such applications as equipment calibration, pressure measurement in production lines, and measurement of fast, varying pressures.**

# The de Facto Standard of Next-generation,

## YOKOGAWA is committed to being the leader in high-accuracy pressure measurement.

The MT210/210F series of digital manometers, produced by combining YOKOGAWA's best pressure measurement technologies, offers excellent accuracy, reliable operation, and a variety of applications. These measuring tools provide the perfect solutions for a wide range of technologies.

Overall structural view of the YOKOGAWA-original silicon resonant sensor\*, a major factor in the high performance of the MT210/210F series.

\* Technology that has won the Ohkochi Grand Technology Prize and the Chairman's Award of the Japan Federation of Economic Organizations (Keidanren).

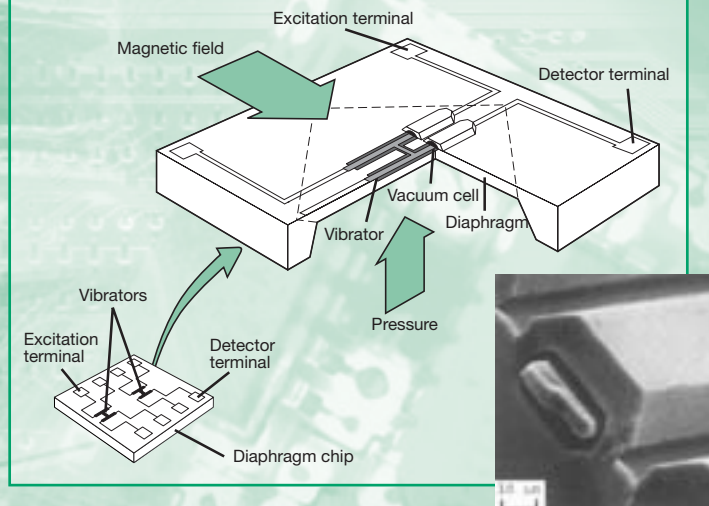

### High performance, high resolution

The MT210/210F series feature high performance, and a high, basic accuracy of  $\pm 0.01\%$  thanks to the YOKOGAWA-original silicon resonant sensor.

### Traceable to national standards

We are prepared to provide services for traceability to Japanese national standards (National Metrology Institute of Japan under the AIST).

See page 4 for the traceability system chart.

### High performance and reliable operation

### High allowable input pressure

The maximum allowable input pressure is as high as 500 kPa (such as in the 130 kPa-range model). Now you don't have to worry about sensor breakdown due to overrange pressure input.

### Minimal effect of temperature changes

The silicon resonant sensor is highly immune to environmental discrepancies such as temperature changes.

# High-accuracy Digital Manometers

**NEW**

## Supports high-speed measurement

The MT210F series has been added to our range of pressure measuring instruments in order to support high-speed measurements. These measurements, such as the observation of transient-response characteristics, include relatively fast pressure changes.

See page 4 for more information and pages 6 and 7 for technical data.

## A wide range of models

You can choose a model to fit your application from models with different pressure types/gauges and absolute and differential pressures. Also choose among models with pressure ranges from the low differential pressure of 1 kPa to the gauge pressure of 3000 kPa.

**NEW**

## Applicable to both gases and liquids

Never be bothered by the labor of switching between models. The MT210/210F series can measure both gases and liquids. With the new differential-pressure models you can measure liquids that you couldn't measure before with the MT110-series differential-pressure models.

## A variety of measurement objectives

## High performance and reliable operation

### Ease of systemization

### Support of field use

**NEW**

## D/A conversion output

The D/A-converted signal of a measured value is output through an external terminal. This feature permits you to easily send data to your measurement system or recorder.

See page 4 for more information and pages 6 and 7 for technical data.

**NEW**

## Comparator output and external trigger input

Use these I/O functions to set the upper and lower limits, judge the measured value, and output the result through an external terminal. What's more, you can apply a start-of-measurement trigger using a falling edge of an external trigger signal. These features will help automate your production/inspection lines of pressure-related products.

## 12-V DC power supply

The MT210/210F operate on a 12-V DC power supply. This feature is useful for in-vehicle tests.

## Operation on Ni-Cd battery pack

The MT210/210F series, which come standard with a built-in battery charger, can continuously operate on an optional Ni-Cd battery pack for approximately 10 hours.

## GP-IB and RS-232 interfaces

This feature lets you read measured values into your PC or set measurement conditions from the PC. Communication is still possible even when the MT210/210F series are operated on batteries or the DC power source.

## Assured compatibility with earlier models

### Inheritance of performance from MT110 Series

The MT210/210F series feature additional functions such as support of high-speed measurement, while inheriting the basic performance from their predecessor, the MT110.

### Common communication commands

The MT210/210F series share the GP-IB and RS-232 communication protocols with their predecessor, the MT110. No modifications to the communication protocols are necessary when expanding a system that uses the earlier series or when replacing the series.

# Functionality and performance supported by stable technology

## Make reliable observations and measurement of rapid pressure changes such as transient-pressure responses.

- Measurement mode selection function: MT210F (new version for high-speed measurement)
  - Choose from three speeds: normal, medium, and high
  - Response time: 50 ms max. (for a 130 kPa-range model in high speed mode)
- Dynamic mode: MT210F (models with the /DA option)
  - Simultaneous support of both high accuracy (0.01%) and fast D/A conversion output response when dynamic mode of D/A output is turned on.
  - When used in combination with an oscilloscope or recorder, the MT210/210F series provides fast-transient, smooth waveforms.

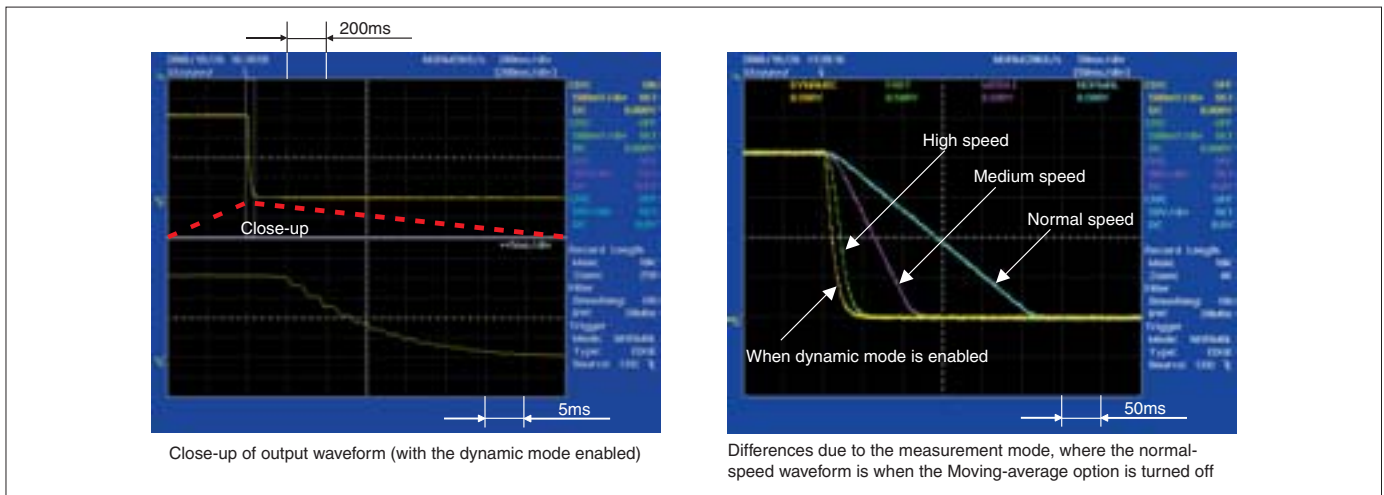

Observation Examples of D/A Conversion Output

## The YOKOGAWA traceability system guarantees reliable pressure measurements for our customers.

The company is committed to controlling and maintaining the accuracy of standards installed in the standards room of its Kofu plant.

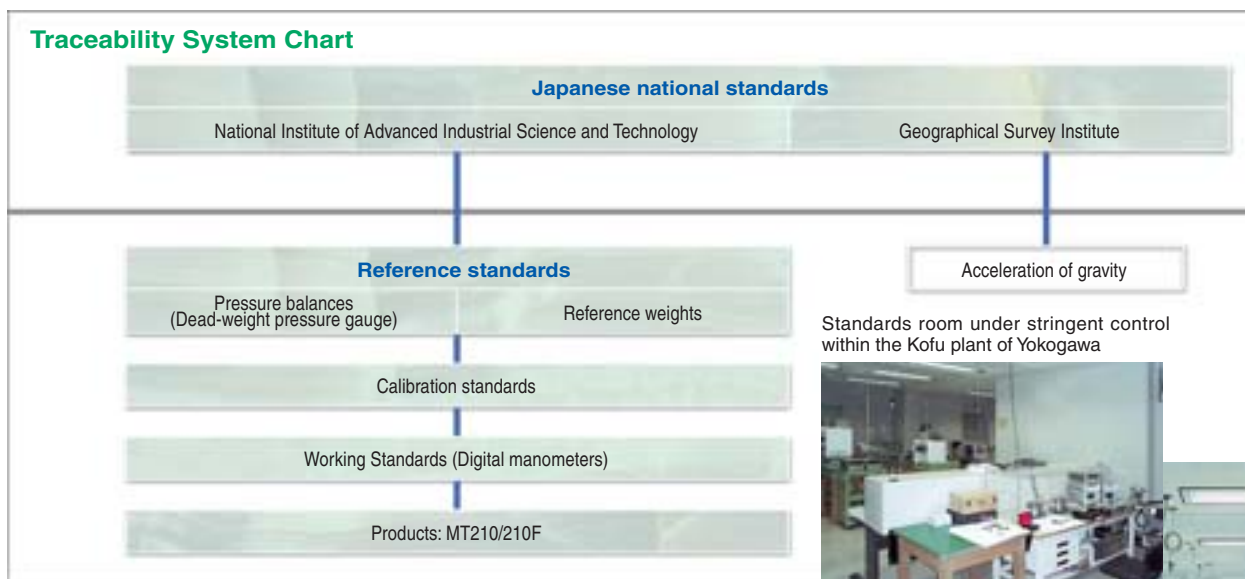

# Supporting a wide range of applications with a wide range of models

We help you increase the accuracy and speed of your measurements over a wide range of pressure measurement applications.

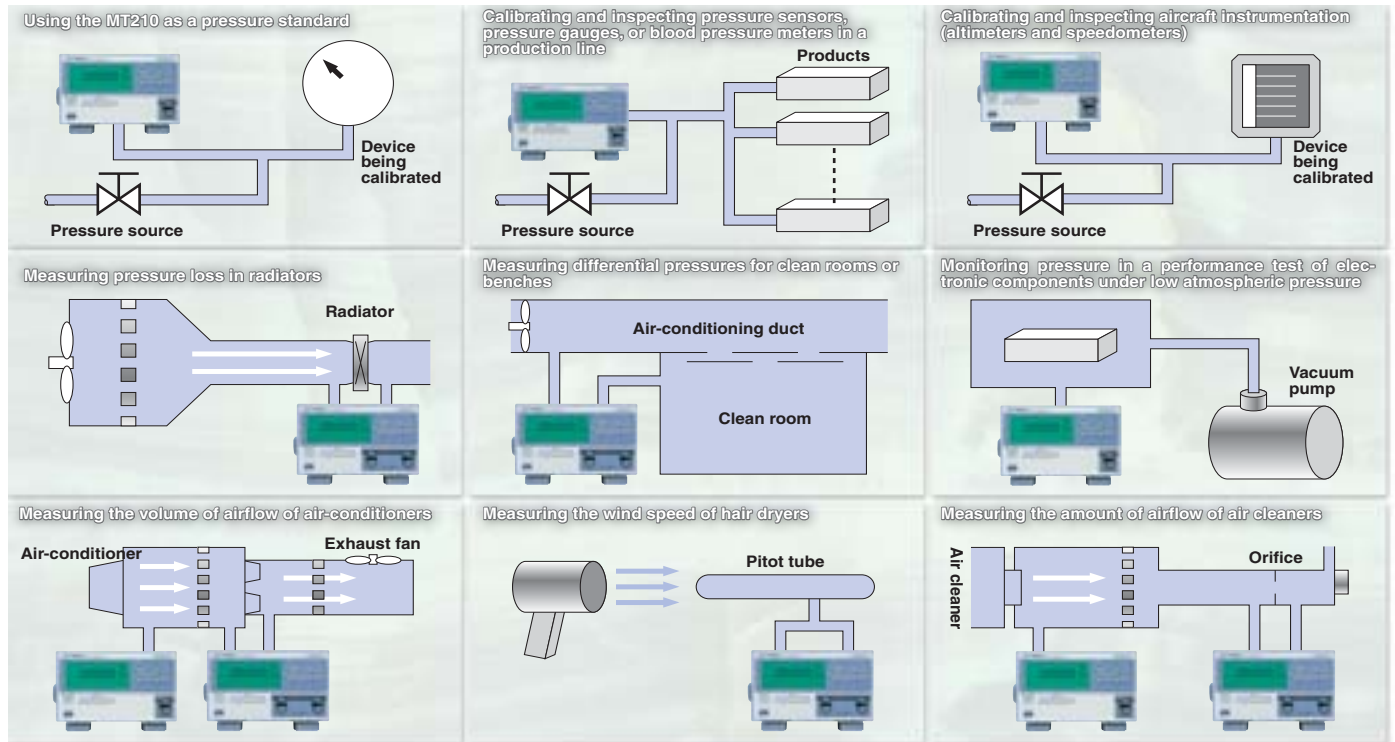

## Other applications include:

Calibrating and inspecting flowmeters; measuring working pressure of pneumatic actuators; measuring pressure in a production/inspection line of valves; controlling the atmospheric pressure of standards rooms; monitoring the pressure of dead-weight pressure gauges; measuring the suction and exhaust pressures of an engine; measuring the static pressure of an engine cooling fan; measuring pressure in wind-tunnel experiments; measuring the pressure of refrigerator coolants; measuring the amount of airflow of ventilating fans; measuring the amount of airflow and static pressure of cooling fans; measuring the wind pressure of heating apparatus; measuring the wind pressure of electric fans; measuring the suction power of vacuum cleaners; measuring the suction pressure of gas fittings during combustion; testing the performance of gas valves for hot-water supply apparatus; and measuring the ventilation performance of houses.

## Major users of YOKOGAWA digital manometers include (information only):

National standards institutions in Japan and abroad; institutions related to nuclear power generation; national and public research institutions; electric-power companies; automakers and their affiliates; electric home appliances manufacturers; precision instruments manufacturers; semiconductor and electronic components manufacturers; pharmaceutical manufacturers; heavy electrical machinery builders; oil refinery companies and chemical and petrochemical companies; and engineering companies.

## Components and their functions (differential-pressure model)

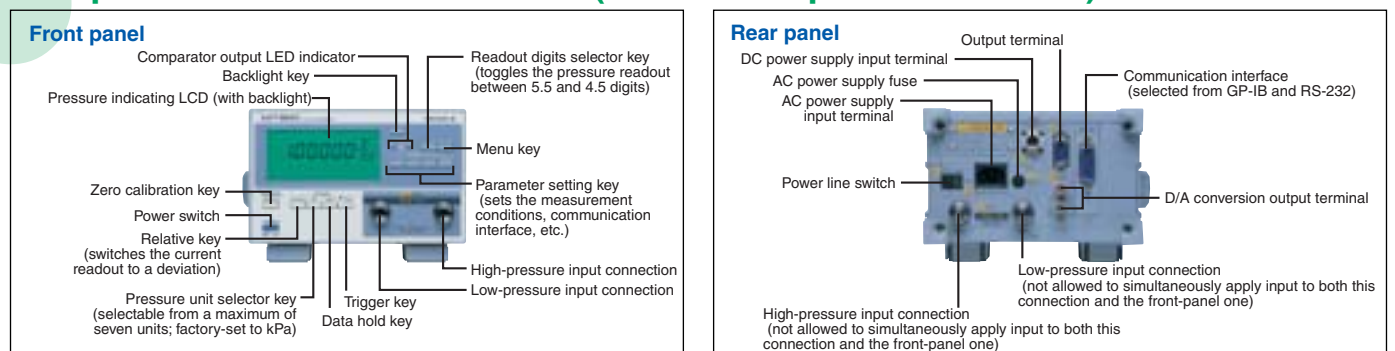

# Specifications

## ■ Pressure-measurement Specifications

### Gauge- and Absolute-pressure Models

Model	767361	767381	767363	767383	767365	767385	767366	767386	767367	767387	
Series	MT210	MT210F	MT210	MT210F	MT210	MT210F	MT210	MT210F	MT210	MT210F	
Pressure type	Gauge								Absolute		
Measurement range (with guaranteed accuracy)	Positive pressure: 0 to 10 kPa Negative pressure: -10 to 0 kPa		Positive pressure: 0 to 130 kPa Negative pressure: -80 to 0 kPa		Positive pressure: 0 to 700 kPa Negative pressure: -80 to 0 kPa		Positive pressure: 0 to 3000 kPa Negative pressure: -80 to 0 kPa		0 to 130 kPa abs		
Readout range	-12.0000 to 12.0000 kPa		Up to 156.000 kPa		Up to 840.00 kPa		Up to 3600.00 kPa		Up to 156.000 kPa abs		
Accuracy <sup>9,10</sup> (Six months after calibration) (Tested at 23±3°C, after zero calibration)	Normal-speed measurement mode	Positive pressure: ±(0.01% of reading + 0.015% of full scale) Negative pressure: ±(0.2% of reading + 0.1% of full scale)		Positive pressure: ±(0.01% of reading + 3 digits) for 20 to 130 kPa ±5digits for 0 to 20 kPa Negative pressure: ±(0.2% of reading + 0.1% of full scale)		Positive pressure: ±(0.01% of reading + 0.005% of full scale) Negative pressure: ±(0.2% of reading + 0.1% of full scale)		Positive pressure: ±(0.01% of reading + 0.005% of full scale) Negative pressure: ±(0.2% of reading + 0.1% of full scale)		±(0.01% of reading + 0.005% of full scale)	
		Medium-speed measurement mode <sup>1</sup> (Add each value to the accuracy in normal-speed measurement mode)	±0.02% of full scale								
		High-speed measurement mode <sup>1</sup> (Add to each value to the accuracy in medium-speed measurement mode.)	±0.04% of full scale		±0.03% of full scale						
Measurement accuracy one year after calibration (add each value to the accuracy six months after calibration)(Tested at 23 ±3°C, after zero calibration)	±(0.01% of full scale)		±(0.005% of full scale)								
Readout update interval <sup>12</sup>	Normal-speed measurement mode	250 ms									
	Medium-speed measurement mode <sup>1</sup>	100 ms									
	High-speed measurement mode <sup>1</sup>	100 ms									
Response time <sup>13</sup>	Normal-speed measurement mode	2.5 s max.									
	Medium-speed measurement mode <sup>1</sup>	200 ms max.									
	High-speed measurement mode <sup>1</sup>	200 ms max.	50 ms max.	70 ms max.	100 ms max.	50 ms max.					
Resolution	0.0001kPa		0.001kPa		0.01kPa		0.01kPa		0.001kPa		
Allowable input	2.7 kPa abs to 500 kPa gauge (50 kPa gauge for MT210F)		2.7 kPa abs to 500 kPa gauge		2.7 kPa abs to 3000 kPa gauge		2.7 kPa abs to 4500 kPa gauge		1 Pa abs to 500 kPa abs		
Internal volume	Approx. 10 cm <sup>3</sup>										
Temperature effect	Zero point: ±0.0015% of full scale/°C Span: ±0.001% of full scale/°C		Zero point: ±0.001% of full scale/°C Span: ±0.001% of full scale/°C								
Effect of positional setup (Zero point drift)	• 90° tilt, forward or backward	±0.1% of full scale		±0.01% of full scale		±0.01% of full scale		±0.01% of full scale		±0.01% of full scale	
	• 30° tilt, right or left	±2.5% of full scale		±0.2% of full scale		±0.05% of full scale		±0.01% of full scale		±0.2% of full scale	
Leak rate	10 <sup>-6</sup> cm <sup>3</sup> /s										
Weight (main unit)	Approx. 8.0 kg		Approx. 6.5 kg		MT210: Approx. 8.0 kg; MT210F: Approx. 6.5 kg		Approx. 6.5 kg		Approx. 6.5 kg		
Applicable fluids	Gases and liquid (non-flammable, non-explosive, non-toxic and non-corrosive fluids)										
Fluid temperature	5 to 50°C										
Liquid viscosity	5 × 10 <sup>-6</sup> m <sup>2</sup> /s max.										
Pressure sensor	Silicon resonant sensor										
Pressure sensing element	Diaphragm										
Readout unit	kPa only, or selection from a group consisting of kPa, kgf/cm <sup>2</sup> , mmHg and mmH <sub>2</sub> O or a group consisting of kPa, psi, inHg, inH <sub>2</sub> O, kgf/cm <sup>2</sup> , mmHg and mmH <sub>2</sub> O; specify when ordering)										
Input connection	Rc1/4 or NPT1/4 female-threaded or VCO1/4 male-threaded <sup>14</sup> (specify when ordering), located on both front and rear panels; however, simultaneous input to connections on both sides is prohibited)										
Material of measurement section	Diaphragm: Hastelloy C276; flange of measurement chamber: stainless steel (JIS SUS316); Internal piping: stainless steel (JIS SUS316); O-ring: fluororubber; input connector: stainless steel (JIS SUS316)										

### Differential-pressure Models

Model	767370	767371	767372	767373	
Series	MT210				
Pressure type	Differential (H-side input ≥ L-side input)				
Measurement range (with guaranteed accuracy)	0 to 1 kPa	0 to 10 kPa	0 to 130 kPa	0 to 700 kPa	
Readout range	-1.20000 to 1.20000 kPa	-12.0000 to 12.0000 kPa	-156.000 to 156.000 kPa	-156.00 to 840.00 kPa	
Accuracy six months after calibration (Tested at 23 ±3°C, after zero calibration)	±(0.015% of reading + 0.03% of full scale)	±(0.01% of reading + 0.025% of full scale)	±(0.01% of reading + 0.01% of full scale + 3 digits) for 20 to 130 kPa ±(0.01% of full scale ±5 digits) for 0 to 20 kPa	±(0.01% of reading + 0.015% of full scale)	
Measurement accuracy one year after calibration (add to the accuracy six months after calibration)(Tested at 23 ±3°C, after zero calibration)	±(0.01% of full scale)		±(0.005% of full scale)		
Readout update interval <sup>12</sup>	250 ms				
Response time <sup>13</sup>	Approx. 5 s max.		2.5 s max.		
Resolution	0.00001kPa	0.0001kPa	0.001kPa	0.01kPa	
Allowable input	1 Pa abs to 50 kPa gauge <sup>18</sup>	2.7 kPa abs to 500 kPa gauge	2.7 kPa abs to 500 kPa gauge	2.7 kPa abs to 1000 kPa gauge	
Internal volume	Approx. 10 cm <sup>3</sup> for both H and L sides				
Temperature effect	Zero point: ±0.005% of full scale/°C Span: ±0.001% of full scale/°C	Zero point: ±0.0015% of full scale/°C Span: ±0.001% of full scale/°C	Zero point : ±0.001% of full scale/°C Span: ±0.001% of full scale/°C		
Effect of positional setup (Zero point drift)	• 90° tilt, forward or backward	±0.5% of full scale	±0.1% of full scale	±0.01% of full scale	±0.01% of full scale
	• 30° tilt, right or left	±3% of full scale	±2.5% of full scale	±0.2% of full scale	±0.05% of full scale
Leak rate	10 <sup>-6</sup> cm <sup>3</sup> /s max.				
Weight (main unit)	Approx. 8.2 kg				
Applicable fluids	Gases and liquid (non-flammable, non-explosive, non-toxic and non-corrosive fluids)				
Fluid temperature	5 to 50°C				
Liquid viscosity	5 × 10 <sup>-6</sup> m <sup>2</sup> /s max.				
Pressure sensor	Silicon resonant sensor				
Pressure sensing element	Diaphragm				
Readout unit	kPa only, or selection from a group consisting of kPa, kgf/cm <sup>2</sup> , mmHg and mmH <sub>2</sub> O or a group consisting of kPa, psi, inHg, inH <sub>2</sub> O, kgf/cm <sup>2</sup> , mmHg and mmH <sub>2</sub> O; specify when ordering)				
Input connection	Rc1/4 or NPT1/4 female-threaded or VCO1/4 male-threaded <sup>14</sup> (specify when ordering), located on both front and rear panels; however, simultaneous input to connections on both sides is prohibited)				
Material of measurement section	Diaphragm: Hastelloy C276; flange of measurement chamber: stainless steel (JIS SUS316); Internal piping: stainless steel (JIS SUS316); O-ring: fluororubber; input connector: stainless steel (JIS SUS316)				

## ■ Specifications of Communication Interfaces (alternative choice)

GP-IB interface	
Electrical and mechanical specifications	Conforms to IEEE Standard 488-1978
Functional specifications	SH1, AH1, T5, L4, SR1, RL1, PP0, DC1, DT1, C0
RS-232 interface	
Transmission method	Start-stop synchronization
Transfer rate	1200, 2400, 4800, 9600 bits/s

## ■ Specifications of "/DA" Option

### D/A Conversion Output

Output voltage	Switchable between 0 to $\pm 2$ V and 0 to $\pm 5$ V to reflect the readout of pressure measurement Example of corresponding output voltages when measured with a 130-kPa gauge-pressure model set to the $\pm 2$ V range: 0 kPa = 0 V 65 kPa = 1 V 130 kPa = 2 V 156 kPa = 2.4 V -80 kPa = -1.230 V
Output resolution	16 bits, where full scale is approximately $\pm 125\%$ of range
Output accuracy (Tested at 23 $\pm 3^\circ\text{C}$ , after zero calibration, using the D/A conversion output terminal)	<ul style="list-style-type: none"> <li>When dynamic mode is on (MT210F only) <math>\pm 0.5\%</math> of full scale<sup>5</sup></li> <li>When dynamic mode is off Add <math>\pm 0.05\%</math> of full scale to accuracy in the Specifications of Pressure Measurement section.</li> </ul>
Temperature effect	$\pm (0.005\%$ of full scale) $^\circ\text{C}$
Output update interval	Approx. 2 ms
Response time	<ul style="list-style-type: none"> <li>When dynamic mode is on (MT210F only) Same as the response time specified for the high-speed measurement mode.</li> <li>When dynamic mode is off Same as the response time specified for the selected measurement mode.</li> </ul>
Output resistance	0.1 $\Omega$ max.
Load resistance	1 k $\Omega$ min.

### Comparator Output

Output signal	HIGH, IN, LOW, BUSY
Operation	HIGH = 1, if measured value > upper limit. IN = 1, if upper limit $\geq$ measured value $\geq$ lower limit. LOW = 1, if measured value < lower limit. BUSY = 1, if there is a transition in the output signal. An LED lamp on the display corresponding to HIGH, LOW or IN comes on.
Signal level	TTL

### External Trigger

Input level	TTL
Operation	A start-of-measurement trigger is applied at a falling edge when the high-state level of an external signal is input with the HOLD function enabled. At the moment of triggering, the LED lamp on the front panel comes on.

## ■ Common Specifications

Display	LCD (with backlight); number of readout digits: 5.5 or 4.5 <sup>6</sup> digits,
Warm-up time	Approx. 5 minutes
Operating temperature/humidity ranges	5 to 40 $^\circ\text{C}$ <sup>7</sup> /20 to 80% RH (no condensation)
Altitude of operation	2000 m max.
Storage temperature range	-20 $^\circ\text{C}$ to 60 $^\circ\text{C}$
Power Supply	AC, DC, Ni-Cd batteries (optional)
AC power rating	100 to 120/200 to 240 V AC, at 50/60 Hz
Allowable supply voltage range	90 to 132 V/180 to 264 V AC
Allowable supply frequency range	47 to 63 Hz
DC power rating	10 to 15 V DC
Battery pack (optional)	Ni-Cd batteries: Last approximately 10 hours in continuous operation mode when fully charged (tested with the backlight turned on). Battery charger: Built in the MT210/210F main unit. Recharge time: Approx. 12 hours
Power consumption	When in pressure measurement mode: 25 VA max. for 100-V power line; 40 VA max. for 200-V power line When in recharge mode: 45 VA max. for 100-V power line; 65 VA max. for 200-V power line When in DC-powered operation: 10 VA max.
Insulation resistance	20 M $\Omega$ min. at 500 V DC, between AC power supply and casing
Withstanding voltage	1500 V AC (50/60 Hz) for 1 minute, between AC power supply and casing
External dimensions	Main unit: Approx. 132 mm $\times$ 213 mm $\times$ 350 mm, excluding protrusions Battery pack (optional): Approx. 33 mm $\times$ 182 mm $\times$ 260 mm, excluding protrusions
Weight	Main unit: See the Specifications of Pressure Measurement section. Battery pack: Approx. 2.7 kg
Accessories	Connector for DC power supply (1), rubber pads for rear feet (2), labels for indicating measurement object, power cord (1), instruction manual (1)

- MT210F only; the measurement mode can be selected from normal speed, medium speed and high speed.
- The interval of outputting data via communication is the same as the readout update interval.
- Conditions of response time measurement
  - The response time is defined as the interval from the start of change to the time the readout settles to within  $\pm 1\%$  of its final value.
  - The manometer under test is made open to the atmospheric pressure when it is at its full-scale value, where the input section is under no load. In the case of absolute-pressure models, the manometer under test is made open to the atmospheric pressure at a scale value of 0.
  - Measurement is performed using the D/A conversion output.
- VCO is a registered trademark of Swagelok Company. A conversion connector is attached.
- $\pm 0.7\%$  of full scale for the 767381 only.
- The 4.5 or 3.5 Digit option applies to the 767365, 767373 and 767385 only.
- 10 $^\circ\text{C}$  to 35 $^\circ\text{C}$  for the 767370 only.
- The difference between L and H is less than 50kPa.
- Yokogawa's pressure standards accuracy is excluded.
- Long term stability of zero point is excluded.

## ■ External Dimensions

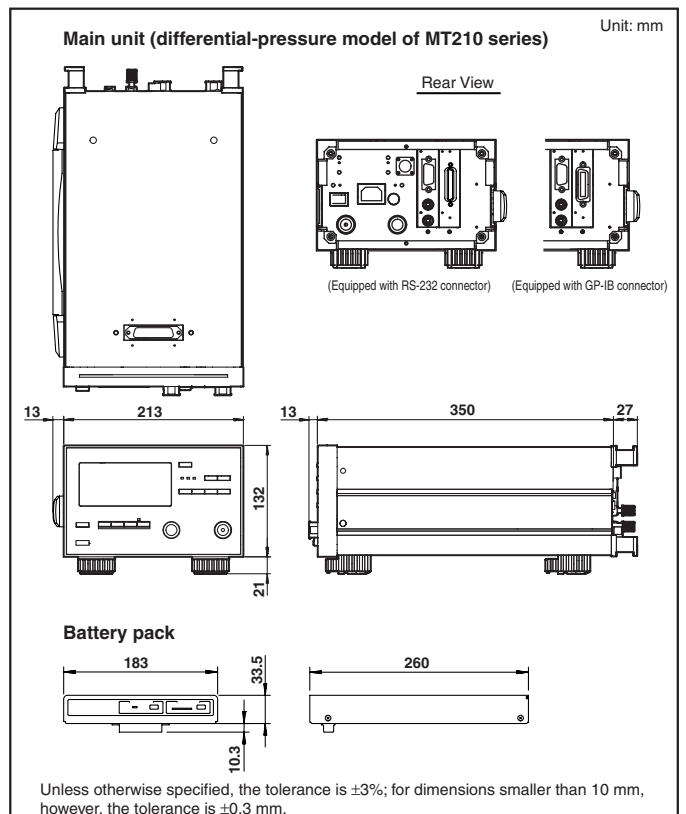

## Models and Suffix Codes

### Main Units

Product	Model	Suffix Code	Remarks
MT210 series of digital manometers	767361	—	10 kPa-range, gauge-pressure model
	767363	—	130 kPa-range, gauge-pressure model
	767365	—	700 kPa-range, gauge-pressure model
	767366	—	3000 kPa-range, gauge-pressure model
	767367	—	130 kPa-range, absolute-pressure model
	767370	—	1 kPa-range, differential-pressure model
	767371	—	10 kPa-range, differential-pressure model
	767372	—	130 kPa-range, differential-pressure model
	767373	—	700 kPa-range, differential-pressure model
MT210F series of digital manometers	767381	—	10 kPa-range, gauge-pressure model
	767383	—	130 kPa-range, gauge-pressure model
	767385	—	700 kPa-range, gauge-pressure model
	767386	—	3000 kPa-range, gauge-pressure model
	767387	—	130 kPa-range, absolute-pressure model
Pressure unit	-U1		kPa
	-U2		kPa, switchable to kgf/cm <sup>2</sup> , mmHg or mmH <sub>2</sub> O
	-U3		kPa, switchable to psi, inHg, inH <sub>2</sub> O, kgf/cm <sup>2</sup> , mmHg or mmH <sub>2</sub> O
Communication interface	-C1		GP-IB
	-C2		RS-232
Input connection	-P1		Rc 1/4
	-P2		NPT1/4 female-threaded
	-P3		VCO 1/4 male-threaded*
Power cord**	-D		UL/CSA standard
	-F		VDE standard
	-H		GB standard
	-R		AS standard
	-Q		BS standard
Option	/DA		D/A conversion output, comparator output and external trigger input

\* VCO is a registered trademark of Swagelok Company.

\*\* The power cord must be changed if a 200-V power line is used. Consult the manufacturer.

### Optional Accessories

Product	Model	Remarks
Battery pack	269913	Ni-Cd batteries for MT210/220 series
Ni-Cd batteries	269914	A kit of three Ni-Cd batteries for the 269913 battery pack
Carrying case	B9320ND	For use with MT210/220 series
Connector assembly kit	B9984BY	For use with $\phi 4 \times \phi 6$ PVC tubing (for "-P1" option)
Connector assembly kit	B9984BW	For use with $\phi 4 \times \phi 6$ PVC tubing (for "-P2" option)
Simplified connector assembly kit	B9310ZH	For use with $\phi 4 \times \phi 6$ PVC tubing
Adapting connector	G9612BG	JIS; R1/4-to-Rc1/8
Adapting connector	G9612BJ	ANSI; R1/4-to-NPT1/4 female thread
Adapting connector	G9612BW	ANSI; R1/4-to-NPT1/8 female thread

### Adapting Connectors for Input Section

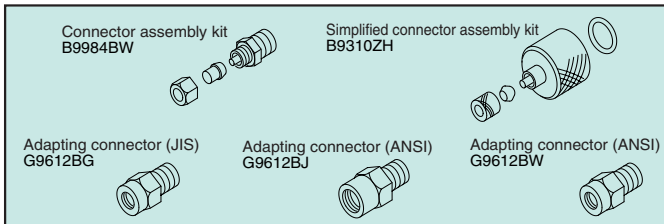

## Related Products

### MT10 Mini-manometer

- Highly reliable design based on silicon resonant sensor
- Compact
- High accuracy:  $\pm(0.04\%$  of reading + 0.03% of full scale) for 130 kPa-range model
- Three choices of pressure range: 130, 700 and 3000 kPa
- Simple operation
- Data hold function
- RS-232 interface



### MC100 Pressure Standard

- High accuracy:  $\pm(0.05\%$  of full scale)
- Excellent stability of operation based on silicon resonant sensor
- Two choices of pressure ranges: 25 and 200 kPa
- Output divider function for generating fractions of a pressure setpoint, to a maximum resolution of 1/20
- Output autostep function
- Output sweep function
- Offset monitor function



### Carrying Case

Picture of B9320ND carrying case



### NOTICE

- Before operating the product, read the instruction manual thoroughly for proper and safe operation.
- If this product is for use with a system requiring safeguards that directly involve personnel safety, please contact the Yokogawa sales offices.

# YOKOGAWA

YOKOGAWA ELECTRIC CORPORATION  
Communication & Measurement Business Headquarters /Phone: (81)-422-52-6768, Fax: (81)-422-52-6624  
E-mail: tm@cs.jp.yokogawa.com

YOKOGAWA CORPORATION OF AMERICA Phone: (1)-770-253-7000, Fax: (1)-770-251-6427  
YOKOGAWA EUROPE B.V. Phone: (31)-88-4641000, Fax: (31)-88-4641111  
YOKOGAWA ENGINEERING ASIA PTE. LTD. Phone: (65)-62419933, Fax: (65)-62412606

Subject to change without notice.  
[Ed : 02/b] Copyright ©2000  
Printed in Japan, 906(KP)