

YOKOGAWA 

Clamp-on Power Meters

Models CW120, CW121 Model CW240 AP240E Data Analysis Program



AP240E Data Analysis Program

Power Quality

CW240  



Energy Saving

CW120  

Realization of Power & Power Quality Management using a CW240

CASE 1

Get a view of energy consumption!

It is essential to measure energy and manage consumption of each sector such as facility and production line for your energy saving activities and to minimize loss.

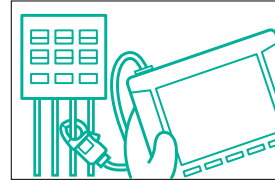

CASE 2

Contribute for improving productivity!

Constantly analyze productivity by managing unit consumption. Managing voltage, current, electric power and power factor makes for good maintenance of production facility. Moreover, you can check operation management loss and enhance productivity.



CASE 3

Discover of electric power waste!

Measure and collect data of electric power consumption by short period. The CW240 can figure out load of production process, and has the ability to check wasteful time and current flow of standby load current.

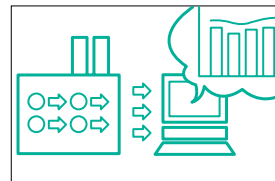

CASE 4

Detect voltage fluctuation!

When trouble occurs on supply side of electric power, instantaneous voltage drop can affect quality of produced goods at the factory. The CW240 is useful for collecting data such as voltage fluctuation to prevent such problems.



Characteristics of CW240

- Simultaneous measurement of instantaneous value, electric energy, demand, harmonics and voltage fluctuation.
- Simultaneous measurement of loads in 4 systems of up to 1P2W
Simultaneous measurement of loads in 2 systems of up to 1P/3P3W
- Data saving interval can be set from 1 waveform (for instantaneous measurement) to 1 hour.
- Measure up to 50th order harmonics
- 4ch leakage current measurement using newly released clamp probe 96036
- Long time data logging by using compact flash memory.
- Multi language for the display (English, German, French, Italian, Spanish, Korean and Chinese)
- 2ch analog input (Optional)
Equipped with 4ch analog output (recorder output)
- AC adaptor for power supply. NiMH rechargeable battery and alkaline battery for backup

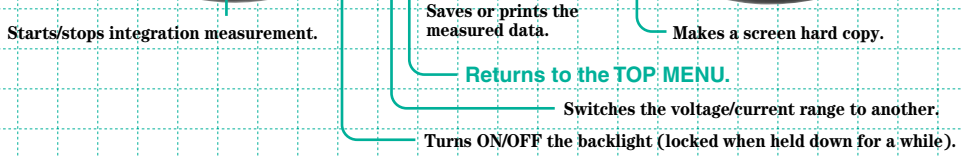
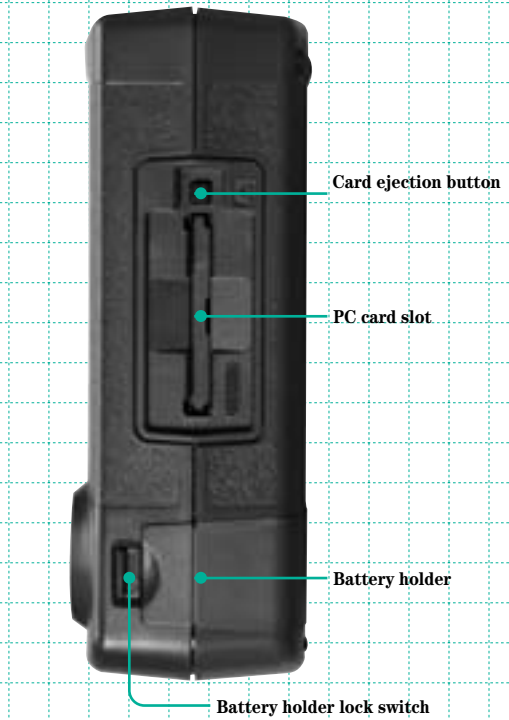
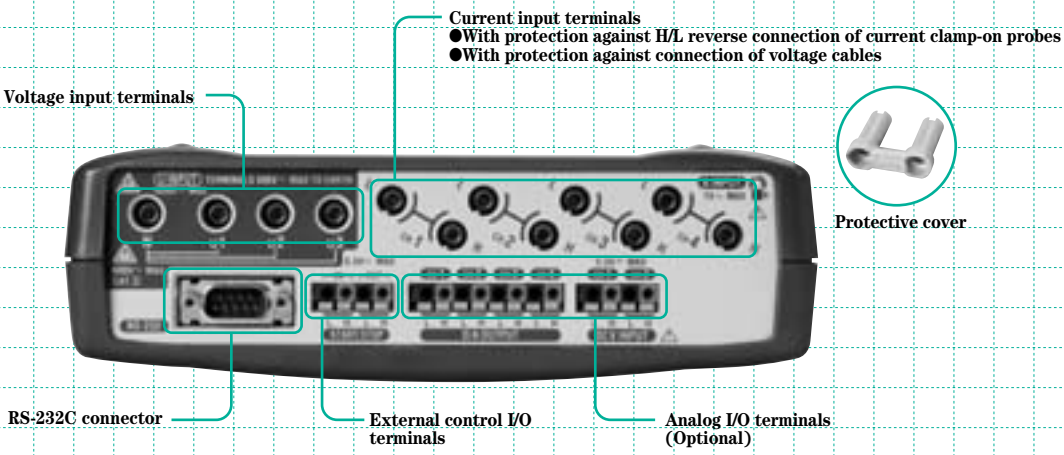
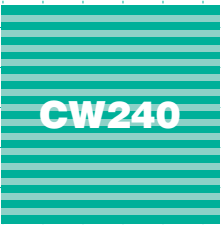

System Configuration Block Diagram

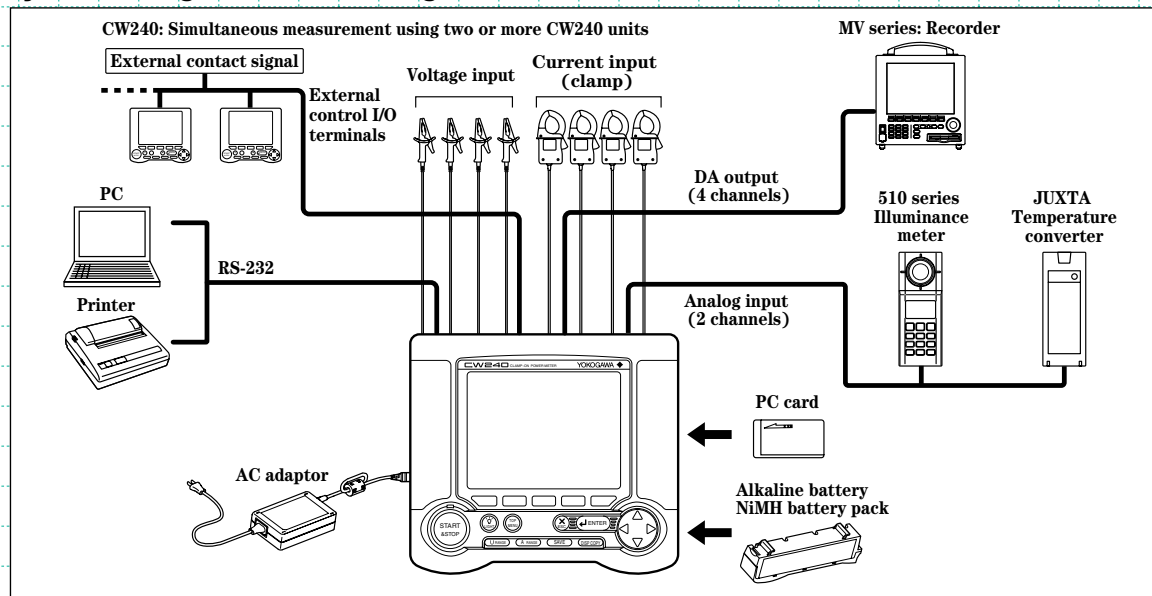

510 series Illuminance meter Product of Yokogawa Meters & Instruments Corporation
 MV series: Recorder and JUXTA Product of Yokogawa Electric Corporation



Power Investigation Improves power Efficiency Through Detailed Data Coll

Measurement of Instantaneous Value: For investigation of power consumption, maximum load factor and peak current

The CW240 can be used to carry out investigation regarding renewal of electric equipment such as transformers in building, check load factors and demand factors, and to check current/voltage fluctuation at motor start-up.

(Example of screen display)

LIST	END	LOAD1	INST.	2004.06.08	13:33:43
U1	211.9 V	11	9.39 A	WIRING	3P3W31
U2	211.0 V	12	7.85 A	LOAD	1
U3	214.0 V	13	13.14 A	U	300V
Uave	212.3 V		10.12 A	x 1.00	A 20A
P	0.08 kW	PA	-88.7 °	x 1.00	
Q	-0.37 kVar	f	50.00 Hz		
S	3.74 kVA	DC1	0.0 mV	PLL	UI 50Hz
PF	-0.054	DC2	0.0 mV	INTER.	10min

POWER	END	LOAD1	INST.	2004.06.08	13:28:18
P1	0.60 kW	Q1	0.87 kVar	WIRING	3P3W31
P2	0.82 kW	Q2	-0.46 kVar	LOAD	1
P3	-1.34 kW	Q3	-0.88 kVar	U	300V
P	0.08 kW	Q	-0.37 kVar	x 1.00	A 20A
S1	1.14 kVA	PF1	0.523	x 1.00	
S2	0.94 kVA	PF2	-0.870	x 1.00	
S3	1.60 kVA	PF3	-0.834	x 1.00	
S	3.68 kVA	PF	-0.063		
PA1	58.5 °	PA	-88.9 °	PLL	UI 50Hz
PA2	-29.6 °			INTER.	10min
PA3	-146.5 °				

POWER	END	LOAD1	AVE.	2004.06.08	13:33:33
P1	0.60 kW	Q1	0.88 kVar	WIRING	3P3W31
P2	0.84 kW	Q2	-0.46 kVar	LOAD	1
P3	-1.34 kW	Q3	-0.88 kVar	U	300V
P	0.11 kW	Q	-0.38 kVar	x 1.00	A 20A
S1	1.15 kVA	PF1	0.522	x 1.00	
S2	0.96 kVA	PF2	-0.872	x 1.00	
S3	1.61 kVA	PF3	-0.830	x 1.00	
S	3.72 kVA	PF	-0.062		
PA1	58.6 °	PA	-86.5 °	PLL	UI 50Hz
PA2	-29.3 °			INTER.	10min
PA3	-33.9 °				

Allows switching data from one to another and saving data.

- **Measurement elements** : Voltage/current/electric power (active, reactive, apparent)/power factor/phase angle of each phase, average/minimum/maximum values of each measurement element.
- **Data collection time** : 1/2/5/10/15/30 seconds, 1/2/5/10/15/30/60 minutes
One cycle (waveform), 100/200/500 ms (short time interval)

Convenient functions

Use of the 3-wattmeter method enables display of instantaneous value of each measurement element.



Investigation into Energy Saving at Factories and Buildings

Food processing plant Facility investigated: Pumps

Purpose : To review the current power equipment, and replace it if necessary but with low investment cost

- Solution 1** : Calculation of the amount of used water based on power consumption since flow meters are expensive
- Solution 2** : Introduction of invert pump control

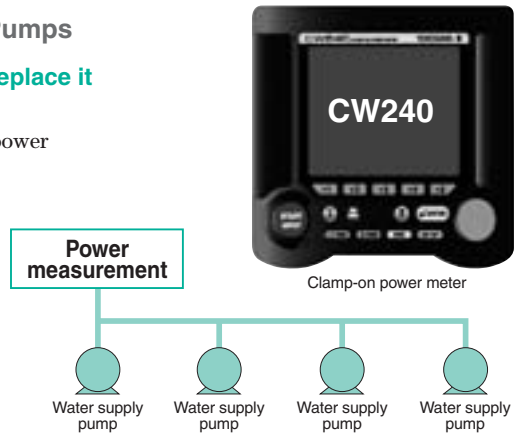
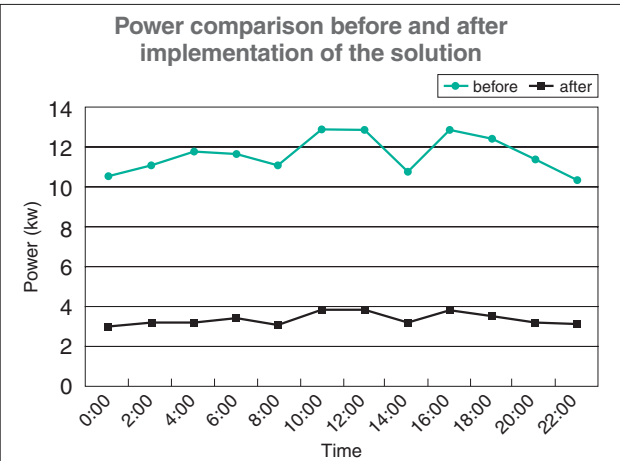

AP240 Suitable for Data Analysis!



Energy saving & Reduce electricity bill

Power Quantity Measurement: For Power-Saving Diagnosis and Data Collection for ISO14001

The CW240 can measure and display the power quantity consumed up to the specified time (from the start of integration until the end).

- **Measurement elements** : Active power quantity, regenerative power quantity, reactive power quantity (leading/lagging)
- **Data collection time** : 1/2/5/10/15/30 seconds, 1/2/5/10/15/30/60 minutes

(Example of screen display)

INTEGRATE	END	LOAD1	2004/06/08 13:25:32
WIRING	3P3W3I	LOAD	1
Wh +	0.509kWh		
Wh -	-0.189 kWh		
Varh -LAG-	0.000 kVarh		
Varh -LEAD-	-1.136 kVarh		
START TIME	2004/06/08	10:23:02	PLL
STOP TIME	2004/06/08	13:24:37	UI 50Hz
ELAPSED TIME	0003:01:35		INTER.
			10min
DISPLAY	CHANGE	SETTING	HOLD /Clear
		CHECK	

Convenient functions

The number of display digits and display units can be selected.

- Standard (Voltage/current range is selected according to the phase)
- Arbitrary (Decimal point position and display unit can be specified)
- Auto (Decimal point position and display unit are selected automatically according to the integration result)

Demand Measurement: For Review and Investigation on Contract Demand

- **Measurement elements** : Maximum power demand required since the start of logging measurement and the time it occurs
Active power, reactive power (lag), power factor
Active power quantity (consumption, regeneration), reactive power quantity (lagging/leading)

(Example of screen display)

DEMAND	END	LOAD1	2004/06/08 11:13:02
WIRING	3P3W3I	LOAD	1
MAXIMUM DEMAND	0.12 kW 2004/06/08 11:13:02		
DEMAND VALUE	INTER.ELEC.ENERGY	U	300V
P 0.11kW	Wh+	0.000kWh x 1.00	
Q 0.00kVar	Wh-	0.000kWh x 1.00	
PF -0.063	Varh+	0.000kVarh x 1.00	
	Varh-	0.000kVarh	
START TIME	2004/06/08	10:23:02	PLL
STOP TIME	2004/06/08	13:24:37	UI 50Hz
DEMAND REST TIME	00:08:25		INTER.
			10min
DISPLAY	CHANGE	SETTING	HOLD /Clear
		CHECK	

Convenient functions

Normally, the demand time limit is set to 30 minutes in the contract with a power company. However, the CW240 allows you to set the desired demand time limit in units of seconds/minutes.

Demand time limit setting : 1/2/5/10/15/30 seconds, 1/2/5/10/15/30/60 minutes

- **Demand**
Demand time limit : Length of time set to obtain the average power (normally 30 minutes)
Demand power : Average power during the demand time limit

Energy Saving and Maintenance for Electric Equipment at Factories and Buildings

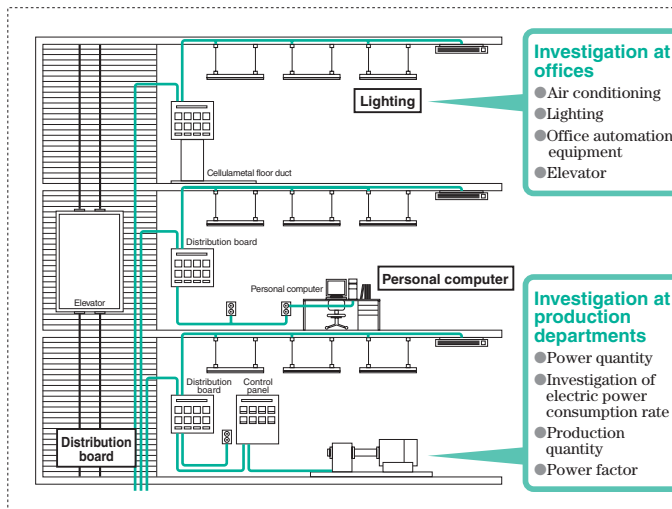

- CW240 solution (building)**
1. For energy investigation/control for each application and floor
 2. For simple investigation for each shop and tenant
 3. Diagnosis of operational status of equipment such as elevator and air conditioner
 4. Diagnosis regarding renewal of electric equipment

- CW240 solution (factory)**
1. Diagnosis of operational status of equipment such as production equipment and air conditioner
 2. For investigation of electric power consumption rate for each production line
 3. For energy investigation/control for privately-owned electrical power facilities
 4. For control of monthly target energy consumption



Harmonic Measurement

In many cases, inverter power supplies are used to drive air-conditioners and compressors. These power supplies cause distortions in voltages and currents, leading to malfunctions and power loss. Therefore, investigation and control of influences on the main power supplies by harmonics is necessary.

- **Harmonics for analysis** : 1st to 50th
- **Display data** : List, bar graph (linear/log), vector (inflow/outflow judgment)
- **Measurement elements** : Level, content, phase angle (voltage/current/electric power of each harmonic), aggregate value (voltage, current, electric power, power factor), aggregate harmonic distortion factors (THD-F or THD-R) of voltage/current
- **THD-F** : Distortion factor for the fundamental wave, THD-R: Distortion factor for all rms values voltage/current
- **Data collection time** : 1/2/5/10/15/30/60 minutes

Convenient functions

The harmonic whose data is required to be saved can be selected. Inflow/outflow of harmonics can be checked.

- **THD-F** : Distortion factor for the fundamental wave, THD-R: Distortion factor for all rms values

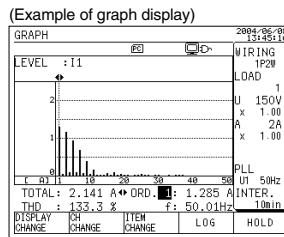

(Example of list display)

[]	[A]	[%]	[deg]	
1	1.305	100.0	0.0	LOAD
2	0.032	2.5	-158.3	1
3	1.162	89.1	162.7	U 150V
4	0.055	4.2	-0.0	x 1.00
5	0.221	70.6	-29.5	A 2A
6	0.063	4.8	172.5	x 1.00
7	0.629	48.2	138.5	
8	0.054	4.1	-1.0	
9	0.342	26.2	-52.0	PLL
10	0.040	3.1	-179.9	UI 50Hz

TOTAL: 2.113 A
THD : 127.4 %
f: 50.00Hz
INTER. 10min

(Influences by harmonics)

Category	Device	Influence type
Power devices	Capacitor, reactor	Overheat, burn, vibration, noise due to excessive current
	Transformer	Overheat, noise, increase in core/copper loss
	Fuse, breaker	Blow-out, malfunction due to excessive current
Electronic/electrical household appliances	Induction motor	Periodic fluctuation of revolution speed, overheat, increase in loss
	Protective relay	Malfunction
	Electrical household appliances	Flickering, noise, malfunction, breakdown
	Fluorescent lamp, mercury-arc lamp	Burn of stabilizer/capacitor, flickering
	Computer	Malfunction, out of control, breakdown
	Electronics device	Malfunction of automatic control part

← Inflow of harmonic
→ Outflow of harmonic

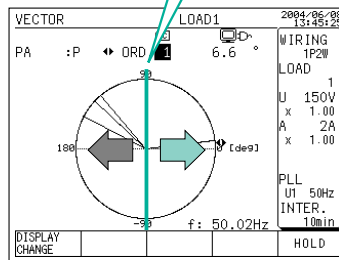

- Explanation of vector diagram**
- Vector length indicates the apparent power of each harmonic in proportion to that of the fundamental harmonic.
 - The horizontal axis shows active power and the vertical axis indicates reactive power. They are shown in a logarithm.
 - Frequencies shown are those of the measurement element actually measured.

Improvement of Harmonic Measurement and Diagnosis

Printing plant

Purpose: To investigate the cause for periodic breakdown of printing machine

It may be caused by harmonics generated in the power lines.

Measurement: Advantages obtained by using the CW240

- Compact and easy to carry
- Measurement of up to the 50th harmonic
- Long-term data collection
- Vector diagram display

Result: Occurrence of harmonics in 5th and 7th was discovered!

In addition, it became clear that harmonics are generated due to loads inside the factory.

In particular, the 5th harmonic causes adverse effects such as burn-out of the serial reactor in the capacitor used to improve the power factor.

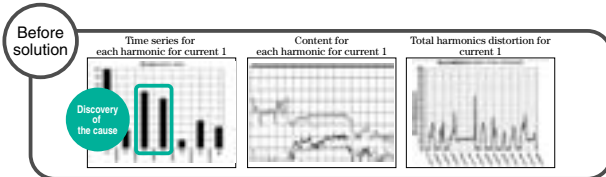

Countermeasure: Installation of transformer filter for 5th and 7th harmonics

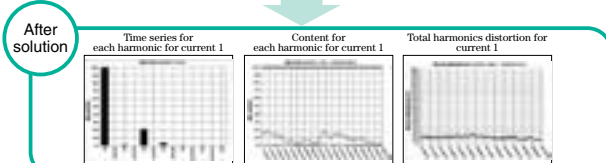

Effects of countermeasures: The contents of 5th and subsequent harmonics decreased drastically and the distortion ratio also dropped below 30%, resulting in elimination of breakdowns.



Waveform Measurement

Measurement elements :

Voltage of each phase, current of each phase
Voltage and current of each phase

Data saving format :

Binary (can be converted to CSV format using a standard application program)

The scale of the vertical axis can be changed from x1/3 to x20.

Easy to understand waveform distortion.

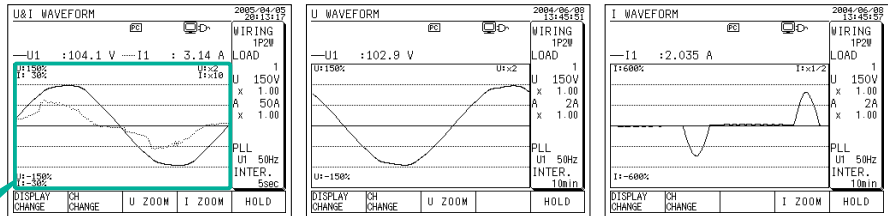

Voltage Fluctuation Measurement

The CW240 detects dates/times of when fluctuations occur, fluctuation type, channels where they occur, rms values, and periods between start and end. The voltage threshold is set, and fluctuations exceeding the threshold are detected.

Measurement element : Voltage dip (voltage drop), voltage swell (voltage rise), instantaneous power failure

Data saving : Detected based on the voltage rms value of one waveform. Up to 100 data sets can be saved.

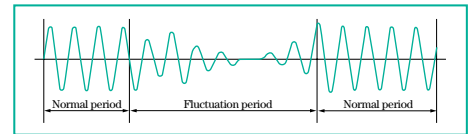

Measurement results

Convenient functions

It is possible to provide a voltage difference between start and end by setting a hysteresis.

Failures in power supply lines

Item	Phenomenon	Problem
Voltage dip (Sag, voltage drop)	A voltage drop occurs for a short time due to the occurrence of a large inrush current, for example, when a motor is started.	Decrease of power supply voltage may cause devices to stop or reset operations.
Voltage swell (Voltage rise)	Voltage increases instantaneously, for example, when lightning occurs or when a power line with a heavy load is turned ON/OFF.	Increase of power supply voltage may cause devices to stop or reset operations.
Instantaneous power failure (Instantaneous stop of power supply)	Power supply is stopped instantaneously or for a short/long time, for example, when a problem occurs in the power supply (suspension of power supply due to lightning, etc.) or due to the trip of a breaker caused by short circuits in the power supply, etc.	Instantaneous power failure may cause devices to stop or reset operations. Recently, various preventive measures have been taken for computers, thanks to widespread use of UPS (uninterruptible power source).

Item
Swe: Swell
Dip: Dip
Int: Instantaneous power failure

Occurrence date

Channel

I: Start 0: End

rms value

Detection period

Power Supply Quality Check at Various Places

Quality check for power supplies used in semiconductor manufacturing equipment in accordance with the SEMI guidelines

Measure stability of the voltage of supplied power according to SEMI S2-0302 (Environmental, Health, and Safety Guideline for Semiconductor Manufacturing Equipment). If a sag (default: within 2%) occurs, the wafer is removed from the line for inspection so daily quality check for power supplies is necessary.

SEMI: Semiconductor Equipment and Materials International
SEMI guidelines are used at the time the contract is made, to evaluate the safety of semiconductor manufacturing equipment when exporting it from Japan to the USA.

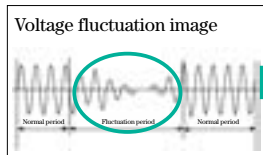

Measurement results



Result:

Occurrence date/time of the sag can be reported so that semiconductor quality can be improved.

Other:

Verification of instantaneous power failure preventive measures implemented in semiconductor manufacturing equipment

Advantages obtained by using the CW240

- Compact and easy to carry
- Detects voltage fluctuations in each cycle. Instantaneous power failures and voltage fluctuations are monitored continuously, and the occurrence and recovery times are reported.

Voltage level (100% as reference)	50% -	70% -	80% -	90% - 110%	- 120%
Fall (rise) time	Within 0.2 sec.	Within 0.5 sec.	Within 10 sec.	No limit	Within 0.5 sec.

Measures Loads in Four Systems Simultaneously.

The CW240 enables simultaneous measurement of loads in four systems in the case of the single-phase 2-wire system, and in two systems in the case of the single/three-phase 3-wire system (common to voltage).

Current clamp probe/range can be set for each system.

► This allows measurement according to the current flowing in each load.

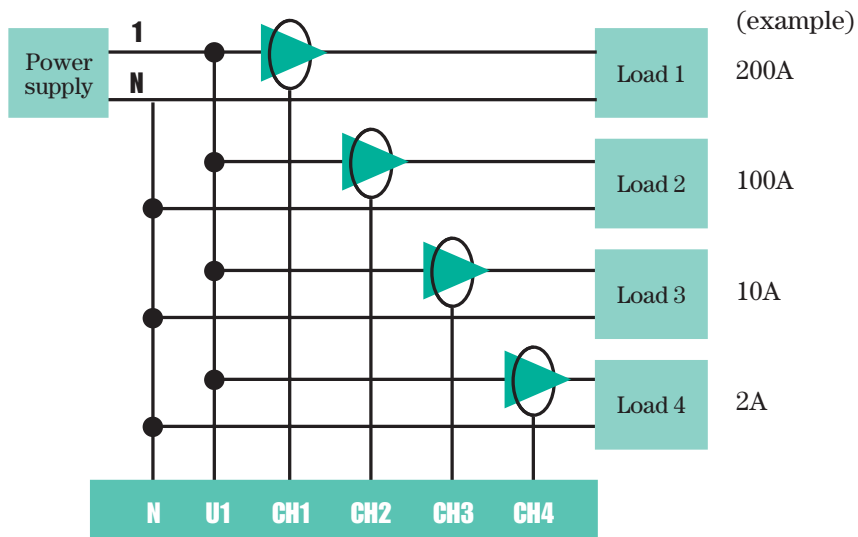

CW240 side Example of single-phase 2-wire system

Reduces Operation Errors at Work Site.

Wiring check function

Prior to start of measurement, the CW240 checks whether wiring is correct. Wiring errors, reverse connection of current clamps, and phases to be checked can be displayed in a vector diagram.

U	V	PHASE	I	FREQ.	PHASE DIF.	FIX	INTER.
U1	165.9 V	0.0deg	8.05 A	50 Hz	U1-11 OK	U1 50Hz	1min
U2	171.3 V	-114.5deg	121.4deg	8.05 A	U2-12 OK	U1 50Hz	1min
U3	172.0deg	-114.5deg	121.4deg	8.05 A	U3-13 NG	U1 50Hz	1min

Setting check function

Settings made for data saving can be checked in the screen. This prevents data acquisition errors that may occur due to mistakes in voltage range setting, current clamp selection or data save item selection.

SET. CHECK

WIRING : 1P2W LOAD : LOAD1

U RANGE : 150V INTER. : 1min

I.A. RANGE : 2A DAT. SAVE : PC CARD

NORMAL MEAS. : ON INST. : ON

HARM. MEAS. : ON AVE. : ON

E. ENERGY/DEM. : ON MAX. : ON

WAVEFORM : ON MIN. : ON

WOL. T. QUALITY : IN

START TIME : MANUAL

STOP TIME : MANUAL

SETUP

To change the settings, press this button to display the setting screen.

Saving a Large Amount of Data

Use of an external memory card (compact flash) makes it possible to save a large amount of data. A memory card ^{(*)1} of up to 512 MB can be used, and the data is saved in CSV format. ^{(*)2} In addition, the CW240 has a 1MB internal memory.

*1: Memory cards purchased from Yokogawa should be used.

*2: Data shorter than one second is saved in binary format. Screen copies can be made in bitmap format. Voltage fluctuation data is saved in text format.

Storage period when PC card (64MB) and internal memory (1MB) are used

When storing all items of measured data, measured power quantity/demand data, and measured voltage fluctuation data

Wiring	1P2W 4 systems	1P3W 2 systems	1P3W31	3P3W21 2 systems	3P3W31, 3P4W	3P4W41	3P3W +1P3W	
Number of storable data items	168	196	114	208	138	142	216	
Recording medium	Interval time							
PC card (64MB)	1s	9 hrs	8 hrs	14 hrs	8 hrs	12 hrs	12 hrs	7 hrs
	1min	24 days	21 days	37 days	20 days	30 days	30 days	19 days
	60min	1471 days	1304 days	2223 days	1232 days	1852 days	1802 days	1188 days
Internal memory (1MB)	1s	8 min	7 min	12 min	7 min	10 min	10 min	6 min
	1min	8 hrs	7 hrs	12 hrs	7 hrs	10 hrs	10 hrs	6 hrs
	60min	21 days	18 days	32 days	17 days	26 days	26 days	17 days

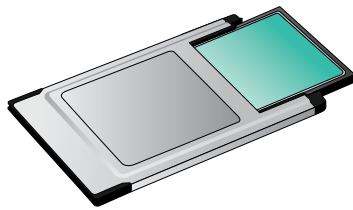

When storing all items of measured data, measured power quantity/demand data, all items of measured harmonics data, waveform data and measured voltage fluctuation data

Wiring	1P2W 4 systems	1P3W 2 systems	1P3W31	3P3W21 2 systems	3P3W31, 3P4W	3P4W41	3P3W +1P3W	
Number of storable data items	5642	5052	3758	6888	4390	5002	7504	
Recording medium	Interval time							
PC card (64MB)	1min	17 hrs	19 hrs	26 hrs	14 hrs	22 hrs	19 hrs	13 hrs
	60min	44 days	49 days	65 days	35 days	56 days	49 days	32 days
Internal memory (1MB)	1min	12 min	13 min	19 min	8 min	16 min	13 min	7 min
	60min	12 min	13 hrs	19 hrs	8 hrs	16 hrs	13 hrs	7 hrs

Leakage Current Measurement

- External magnetic field effect is 0.002A or less, at 400A/m -

Yokogawa's proprietary technology has achieved a magnetic field impact amount of 30 ppm even in adjacent power lines. (At 100A) Use of the 2A current clamp probe (96036) enables measurements with 200.0 mA range.



Current clamp probe 96036

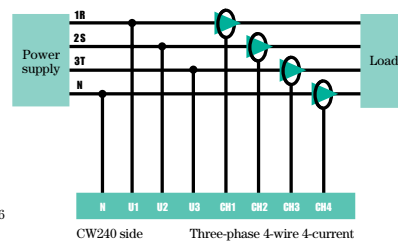

Analog Input/Output

- Besides power data -

Analog data such as temperature and illuminance data can be saved simultaneously with power data by using the analog input function (2 channels).

The available input ranges are 100 mV/1 V/5 V. In addition, the analog output function (4 channels) acquires data to an external recorder, allowing data duplexing. Output is ± 1 VDC. (The analog input/output function is optional.)



Digital illuminance meter 51001

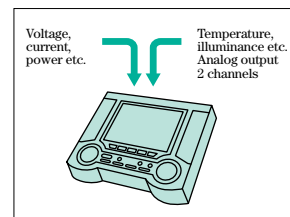

Other Convenient Functions

Power supply backup

Besides the AC adapter, it is possible to use a NiMH battery pack (94004) or alkaline batteries (six AA batteries). The CW240 will continue to operate even if supply of power is interrupted.

Multi-lingual support

The CW240 supports Japanese, English, German, French, Spanish and Italian (available in the near future).

Manual data saving

The data for the selected items can be saved or printed using the SAVE key. However, it cannot be saved during integrating measurement (and during standby).

Screen hard copy

The currently displayed screen can be saved or printed using the DISP COPY key. Files are saved in bitmap format.

Zoom function

The measured data for the selected five items can be zoomed in. The items to be displayed can be selected from instantaneous value and measured power quantity data.

Specifications

Inputs

Item	Voltage	Current
Input type	Resistive potential division	Clamp detection
Rated value (range)	150.0 V 300.0 V 600.0 V 1000 V	Varies with the clamp and range used.
		96036 (2A) 200.0/500.0mA/1.000/2.000A
		96033 (50A) 5.000/10.00/20.00/50.00 A
		96030 (200A) 20.00/50.00/100.0/200.0 A
		96031 (500A) 50.00/100.0/200.0/500.0 A
Phase to be measured	Single-phase 2-wire, single-phase 3-wire, single-phase 3-wire 3-current (current in neutral line), three-phase 3-wire 2-current (2-power meter method), Three-phase 3-wire 3-current (3-power meter method), three-phase 4-wire, three-phase 4-wire 4-current (current in neutral line), Scott connection (three-phase 3-wire + single-phase 3-wire)	96032 (1000A) 200.0/500.0 A/1.000 kA
		96034 (3000A range) 300.0/750.0 A/1.500/3.000 kA
		(2000A range) 200.0/500.0 A/1.000/2.000 kA
		(1000A range) 100.0/200.0/500.0 A/1.000 kA
		96035 (3000A range) 300.0/750.0 A/1.500/3.000 kA
Maximum allowed input (continuous)	1000 Vrms	96036 (2A) 20Arms
		96033 (50A) 130Arms
		96030 (200A) 250Arms
		96031 (500A) 625Arms
		96032 (1000A) 700Arms
A/D converter	Voltage/current input simultaneous conversion, PLL synchronized 128 samples/period, 16-bit resolution	96034 (3000A range) 2400 Arms (3600 Arms for 10 minutes)
		(2,000A range) 2400Arms
		(1000A range) 1200 Arms
		96035 (3000A range) 3600 Arms
		(300A range) 360 Arms

Measurement Functions

Item	Voltage	Current / Active power / Reactive power (reactive power meter method is used)
Method	Digital sampling	
Frequency range	45 to 65Hz (Measurement element is selected from U1, U2 and U3)	
Crest factor	Rated input: 3 (however, 1.8 when 1000V range is used)	
Accuracy	±0.2%rdg.	96030, 96031, 96033, 96036 ±0.6%rdg.±0.4%rng.
	±0.1%rng.	96032, 96034, 96035 ±1.0%rdg.±0.8%rng.
Power factor influence	—	96030 ±1.0%mg (45 to 65Hz, power factor =±0.5)
	—	Other than 96030 ±2.0%mg (45 to 65Hz, power factor =±0.5)
Reactive factor influence	—	96030 ±1.0%mg. (45 to 65Hz, reactive factor =±0.5)
	—	Other than 96030 ±2.0%mg (45 to 65Hz, reactive factor =±0.5)
Active input range	5 to 110% of each range (Max. 100% in the case of 1000V range)	
Display range	Voltage / current: 0.4 to 130% of each range	
	Power (active, reactive, apparent): 0 to 130% of each range	
Temperature coefficient	±0.03%mg/°C	±0.05%mg/°C
Display updating interval	Approx. 0.5 seconds	

rdg: Reading mg: Range

Range Configuration for Active Power

For single-phase 2-wire system (X2 for single/three-phase 3-wire system, X3 for three-phase 4-wire system)

● When 96030 / 96031 / 96032 / 96033 / 96036 is used

Voltage range	Current range											
	96036(2A)						96033(50A)					
	96030(200A)		96031(500A)				96032(1000A)					
	200.0 mA	500.0 mA	1.000 A	2.000 A	5.000 A	10.00 A	20.00 A	50.00 A	100.0 A	200.0 A	500.0 A	1.000 kA
150.0 V	30.00 W	75.00 W	150.0 W	300.0 W	750.0 W	1.500 kW	3.000 kW	7.500 kW	15.00 kW	30.00 kW	75.00 kW	150.0 kW
300.0 V	60.00 W	150.0 W	300.0 W	600.0 W	1.500 kW	3.000 kW	6.000 kW	15.00 kW	30.00 kW	60.00 kW	150.0 kW	300.0 kW
600.0 V	120.0 W	300.0 W	600.0 W	1.200 kW	3.000 kW	6.000 kW	12.00 kW	30.00 kW	60.00 kW	120.0 kW	300.0 kW	600.0 kW
1.000 kV	200.0 W	500.0 W	1.000 kW	2.000 kW	5.000 kW	10.00 kW	20.00 kW	50.00 kW	100.0 kW	200.0 kW	500.0 kW	1.000 MW

● When 96034 / 96035 is used

Voltage range	Current range															
	96035_2(300A)				96034_1(1000A)				96034_2(2000A)				96034_3(3000A)			
		30.00 A	75.00 A	150.0 A	300.0 A	100.0 A	200.0 A	500.0 A	1.000 kA	2.000 kA	300.0 A	750.0 A	1.500 kA	3.000 kA		
150.0 V	4.500 kW	11.25 kW	22.50 kW	45.00 kW	15.00 kW	30.00 kW	75.00 kW	150.0 kW	300.0 kW	45.00 kW	112.5 kW	225.0 kW	450.0 kW			
300.0 V	9.000 kW	22.50 kW	45.0 kW	90.00 kW	30.00 kW	60.00 kW	150.0 kW	300.0 kW	600.0 kW	90.00 kW	225.0 kW	450.0 kW	900.0 kW			
600.0 V	18.00 kW	45.00 kW	90.00 kW	180.0 kW	60.00 kW	120.0 kW	300.0 kW	600.0 kW	1.200 MW	180.0 kW	450.0 kW	900.0 kW	1.800 MW			
1.000kV	30.00 kW	75.00 kW	150.0 kW	300.0 kW	100.0 kW	200.0 kW	500.0 kW	1.000 MW	2.000 MW	300.0 kW	750.0 kW	1.500 MW	3.000 MW			

Equations

Active power, reactive power, apparent power, power factor and phase angle are measured for each phase. The average, maximum and minimum values of those obtained during integrating measurement are calculated.

$$\text{Voltage rms } U_{rms} = \frac{1}{T} \int_0^T u_m(t)^2 dt = \frac{1}{T} \sum_{n=0}^T u_m(t)^2$$

$$\text{Current rms } I_{rms} = \frac{1}{T} \int_0^T i_m(t)^2 dt = \frac{1}{T} \sum_{n=0}^T i_m(t)^2$$

$$\text{Active power } P_m = \frac{1}{T} \int_0^T [u_m(t) \times i_m(t)] dt = \frac{1}{T} \sum_{n=0}^T [u_m(t) \times i_m(t)]$$

Reactive power 1 When the reactive power meter method is used

$$Q_m = \frac{1}{T} \int_0^T [u_m(t) \times i_m(t + \frac{T}{4})] dt = \frac{1}{T} \sum_{n=0}^T [u_m(t) \times i_m(t + \frac{T}{4})]$$

u(t): Voltage input signal
i(t): Current input signal
T: One cycle of input signal
m: Each phase

Equations for Each Phase

Wiring Measurement Items	Equation	Symbol	Single-phase 3-wire	Three-phase 3-wire 2-current ^{*2}	Three-phase 3-wire 3-current	Three-phase 4-wire
Average voltage	—	Uave	(U1 + U2)/2		(U1 + U2 + U3)/3 ^{*1}	
Average current	—	Iave	(I1 + I2)/2		(I1 + I2 + I3)/3 ^{*2}	
Active power	—	ΣP	P1 + P2	P1 + P3	P1 + P2 + P3 ^{*4}	
Reactive power 2 ^{(*)3}	$Q = S^2 - P^2$	ΣQ	Q1 + Q2	$\sum S^2 - \sum P^2$	Q1 + Q2 + Q3 ^{*4}	
Apparent power	S = U × I	ΣS	S1 + S2	$\frac{3}{2}(S1 + S3)$	S1 + S2 + S3 ^{*4}	
Power factor	When the reactive power meter method is not used ^{(*)5}	ΣPF		$\frac{\sum P}{\sum S}$		
	When the reactive power meter method is used	ΣPF		$\frac{\sum P}{\sum P^2 + \sum Q^2}$		
Phase angle ^{(*)6}	—	ΣPA		$\sum PA = \cos^{-1} \frac{\sum P}{\sum S}$		

In the case of distorted waves, there may be differences from other instruments that employ different measurement principles.

- *1: Line voltage is measured in the case of 3-phase 3-wire system, and phase voltage in the case of 3-phase 4-wire system.
- *2: I2 for three-phase 3-wire system (2-power meter method) is calculated by vector operation.
- *3: This equation is applicable when the reactive power meter method is not used. Even in this case, the value is multiplied by the polarity of Q for each phase calculated by the reactive power meter method.
- *4: In the case of three-phase 3-wire system, the phase voltage from the virtual neutral point is used to calculate each phase power.
- *5: Multiplied by the polarity of Q for each phase calculated by the reactive power meter method.
- *6: In the case of distorted waves and unbalanced inputs, there may be differences from other instruments that employ different measurement principles. P1, P3, Q1, Q3, S1, S3, PF1 and PF3 are obtained during calculations carried out by the 2-power meter method, and do not exist as physical values.

■ Specifications of Each Function

● Frequency Measurement Function

Measurement input	Voltage input Selectable from U1, U2 and U3
Measurement frequency range	45 to 65 Hz
Display range	40.00 to 70.00 Hz
Accuracy	±0.1%rdg, ±1dgt For 10% to 130% sine wave input of voltage range
Low-pass filter function	Cutoff frequency: Approx. 300 Hz OFF/ON selectable

● Power Quantity Measurement Function

Measurement elements	Active power quantity, regenerative power quantity, reactive power quantity (lead/lag)
Measurement accuracy	Measurement accuracy of active power and reactive power ±1dgt (When STANDARD is selected for display digits)
Measurement range	Active power quantity Consumption 0.00000 mWh to 999999 GWh Regeneration -0.00000 mWh to -999999 GWh Reactive power quantity Lagging 0.00000 mvarh to 999999 GVarh Leading -0.00000 mvarh to -999999 GVarh
Display digits setting function	Selectable from automatic setting by rated power, minimum resolution setting, and minimum resolution shift by integrated value.
Integration time accuracy	±20 ppm (Typ., 23°C)

● Demand Measurement Function

Measurement elements	Active power (consumption), reactive power (lagging), power factor: Demand value within the interval time Active power quantity (consumption, regeneration), reactive power quantity (lagging), leading: Power quantity within the interval time Maximum demand (consumption power demand) required since the start of integrating measurement and the time it occurs
Measurement accuracy	Measurement accuracy of active power and reactive power ±1dgt (When STANDARD is selected as the standard number of display digits)

● Harmonic Measurement Function

Method	PLL synchronization
Measurement frequency range	Fundamental wave frequency 45 to 65 Hz
Harmonics for analysis	1st to 50th
Window width	1 cycle
Window type	Rectangular
Analysis data quantity	128 points
Analysis rate	1 sample/16 cycles
Analysis items	Harmonic level: Level of each harmonic of voltage, current and power Relative harmonic content: Content of each harmonic of voltage, current and power Harmonic phase angle: Phase angle of each harmonic of voltage, current and power For voltage and current, the phase angle of the fundamental wave or that of U1 can be selected as the reference. Total value: Total value of all the harmonics up to the 50th harmonic of voltage, current, power and power factor Total harmonic distortion rate: Voltage / current (THD-F or THD-R) Harmonic level 1st to 20th: ±1.5%rdg, ±1.5%rng 21st to 30th: ±2.0%rdg, ±1.5%rng 31st to 50th: ±3.0%rdg, ±1.5%rng Relative harmonic content Value calculated from harmonic level ±2dgt Harmonic phase angle The accuracy is guaranteed if both voltage and current levels for each harmonic are 5% of the range or higher. 1st to 20th: ±5° 20th to 50th: ±(0.3° X k+1°) k: Order The accuracy for current in relation to the fundamental wave is not specified.
Accuracy	
Display data	List, bar graph (linear/log), vector

● Waveform Measurement Function

Measurement elements	Selectable from voltage/current waveform of same phase, all voltage waveforms, and all current waveforms.
Magnification change	x1/3 to x 20 in relation to the rating
Display data	1 waveform

● Voltage Fluctuation Measurement Function

Measurement elements	Voltage dip, voltage swell, instantaneous power failure
Measurement method	Detected based on voltage rms of one waveform.
Threshold/hysteresis	Can be set in percentage in relation to the reference voltage.
Accuracy	Same as voltage rms accuracy
Detection period	Time length during which the threshold is exceeded
Display data	Occurrence date (year, month, day), voltage rms, detection period
Number of events	100

● Display Function

Display	5.7-inch STN monochrome LCD display (320 dots x 240 dots) with backlight
Backlight	OFF/ON and auto OFF selectable
Contrast	Automatically adjusted according to the ambient temperature / Settable in 8 steps.
Display digits	Items other than power quantity: 4 digits Power quantity: 6 digits
Language	English, Japanese, German, French, Spanish, Italian, Korean and Chinese
Display average function	Moving average (Averaging count: selectable from 2, 5, 10 and 20)
Display hold	Hold / cancel

● Save/Print Function

Data can be saved/printed manually or automatically.	
Storage media	Internal memory: 1MB or PC card
Printing	Dedicated printer (via RS-232)
Save/print data	Measured data, voltage variation data, waveform data, screen data, setting data
Saving format	Measured data: CSV format (Binary format if short-time interval is set) Voltage variation data: Text format Waveform data: Binary format Screen data: BMP format (bitmap) Setting data: Text format
Save/print interval	
Standard interval:	1/2/5/10/15/30 seconds, 1/2/5/10/15/30/60 minutes It is not possible to output/print measured harmonic and waveform data if the interval is shorter than 30 seconds.

Short-time interval:	0.1/0.2/0.5 seconds for each waveform Only instantaneous values can be input.
----------------------	--

● Data storage time display

Unoccupied capacity in the storage destination
Data save items, calculated based on the interval time.

● File operation

Rename	File names in the internal memory and PC card can be changed.
Deletion	File names in the internal memory and PC card can be deleted.
Format	PC card and internal memory and can be initialized
Data copy	Files in the internal memory can be copied to the PC card.
Setting file	Setting file can be read, written, deleted and renamed.

● Communication Function

Electrical specifications	EIA RS-232
Synchronization system	Asynchronous communication
Baud rates	1200/2400/9600/19200/38400 bps
Connector	D-sub 9-pin

● PC card interface

Slot	PC card slot TYPE II (x1)
Compatible card	ATA flash memory card
Data format	MS-DOS format
Recording contents	Measured data, voltage fluctuation data, waveform data, screen data, setting data

● External control I/O terminals

Used to control start/end of integrating measurement.	
Control input	TTL level or contact
Control output	TTL level

● Analog Input and DA Output Functions (Optional)

DA output	
Output voltage	±1VDC of the rated value for each range Power quantity depends on the output rate. X1, X10 and X100 can be set for harmonics. Frequency: 0.4 to 0.7V / 40 to 70 Hz
Number of output channels	4 channels
Output data (Four items can be selected)	Instantaneous value Voltage, current, average voltage, average current, active power, reactive power, apparent power, power factor, phase angle, frequency Active power quantity (consumption, regeneration), reactive power quantity (lagging/leading)
Power quantity	
Harmonic Accuracy	Level, content, phase angle, total value, THD (THD-F or THD-R) ±(Measurement accuracy + 0.2%f.s.)
Resolution	Polarity + 11 bits
Updating interval	Other than harmonic measurement: 1 cycle of input signal Harmonic measurement: 16 cycles of input signal
Temperature coefficient	±0.02%f.s./°C or less
Output resistance	22Ω±5%
Power quantity output route	Selectable from 1V/1kWh, 1V/5kWh, 1V/10kWh, 1V/50kWh, 1V/100kWh, 1V/500kWh and 1V/1000kWh.
Analog input	
Input ranges	100mV/1V/5VDC
Number of inputs	2 channels
Accuracy	±0.5% f.s
Resolution	Polarity + 11 bits
Sampling rate	Approx. 20ms
Input resistance	Approx. 100kΩ

● Clock Function

Automatic calendar, automatic leap-year setting, 24-hour system	
Real-time accuracy	±20 ppm (Typ., 23°C)

● Wiring Check Function

Verification of validity of measurement of voltage/current input value, voltage/current phase difference, voltage-to-voltage phase difference, current-to-current phase difference and frequency
Verification of single-phase load (in the case of Scott connection)
Wiring diagram, vector diagram display

● Setting Check Window

Used to check data save items and start/end for integrating measurement.

● Other functions

VT ratio/CT ratio setting, ID number setting, NiMH (nickel hydride battery) charge, remaining battery voltage display, beep sound (key operation), key lock, system reset

● General specifications

Location for use:	Indoor, at an altitude of 2000 meters or less
Storage temperature and humidity ranges	-20 to 60°C, 90%RH (no condensation)
Operating temperature and humidity ranges	5 to 40°C, 5 to 80%RH (no condensation)
Insulating resistance	500 VDC, 50MΩ or greater Between voltage input terminals and case Between voltage input terminals and current input terminals / DC power terminals / external interface terminals
Insulating withstand voltage (50/60Hz, for one minute)	5.55 kVAC rms for one minute (Sensed current: 1mA) Between voltage input terminals and case 3.32 kVAC rms for one minute (Sensed current: 1mA) Between voltage input terminals and current input terminals / DC power terminals / external interface terminals
Power supply	AC adaptor (standard accessory), 100 to 240 VAC, 50/60Hz
Backup battery (for power failure)	Six AA size alkaline batteries (standard accessory) One NiMH battery pack (optional)
Maximum rated power consumption	Main unit: Approx. 10W (normal operation), approx. 20W (during charging of NiMH battery pack) AC adaptor: Approx. 30VA (normal operation), approx. 60VA (during charging of NiMH battery pack)
External dimensions	Approx. 206 (W) × 184 (H) × 65 (D) mm (excluding projecting parts)
Weight	Approx. 1.2 kg (without batteries)

● Accuracy guarantee conditions

Warm-up time	30 minutes or more (within active input range, sine wave input, power factor=1, PLL synchronization)
Accuracy guarantee temperature and humidity ranges	23±5°C, 30 to 75%RH
Accuracy guarantee frequency range	45 to 65Hz
Accuracy warranty period	1 year

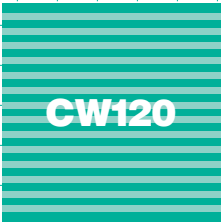

Model CW120 Clamp-on Power Meter

Maintenance and long term monitoring of electrical equipment and electrical system.



Model CW121-□-1

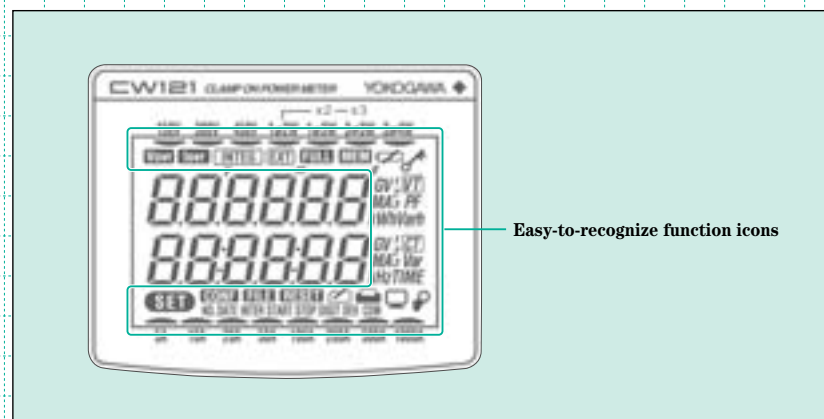

Low-cost tools to support your energy conservation efforts

As energy conservation becomes increasingly important, we are pleased to present low-cost clamp-on power meters designed to meet user needs for simple tools capable of measuring power values and instantaneous values.

Useful features for energy conservation and power measurement

● **Periodically save data as often as once a second**

Data can be saved as low as 1-second interval. This capability allows the CW120 Series to respond quickly to load fluctuations and measure transient responses in equipment.

● **Check equipment operating conditions**

The CW120 Series has an instantaneous value filing function (enabling multiple data records to be saved in a single file when multiple measurements are taken) which is useful for determining equipment operating conditions.

● **Wiring error check function**

This function helps ensure that measurement operations are correct.

● **Simultaneous measurement of multiple facilities**

Multiple CW120 Series units can start and stop integration simultaneously through externally controlled I/O.

● **Works even with small electric energy values**

Easily change the decimal position (the number of digits following the decimal point) and display unit (Wh, kWh, MWh, GWh) on the electric energy display.

Details for Models CW120/CW121

Items		CW120/CW121
Measurement Mode	Input system	Single-phase 2-wire to 3-phase 4-wire
	Instant mode	(Up to 3 phase 3 wire for CW120)
	Electric Energy mode	Available
Display	Screen	Segmented LCD with backlight
Communication	Interface	RS232 or RS485
	Protocol	MODBUS, PC-link, Power-Monitor, Proprietary
	Monitoring by AP240E	Available
Power supply		100 to 240V AC, Supply the power from input.
Size (W×H×D)		117×161×51mm
Weight		600g

Load measurements on multiple systems

● In addition to support for a variety of connection types, The CW120 Series can simultaneously measure the loads* (facilities, equipment) on multiple systems sharing a common power supply.

CW120 (three-phase 3-wire model): 1ø2W×2

CW121 (three-phase 4-wire model): 1ø2W×2, ×3

1ø2W Three current systems (example)

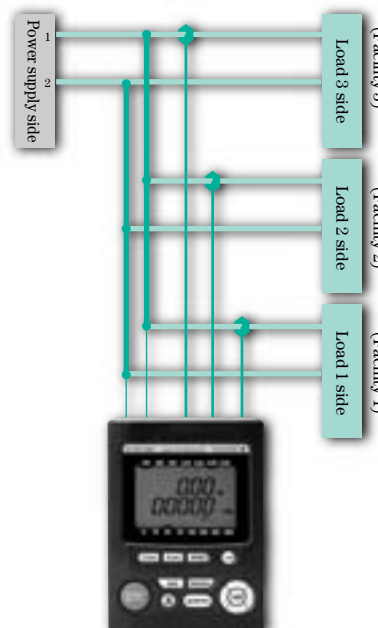

Low-cost tools to support your energy conservation efforts

Compact design

- The CW120 Series is compact in size (117×161×51mm (W×H×D)), making it ideal for installation in cubicles and inside distribution panels. Installation is even easier with the magnetic case (93023).
- Although the CW120 Series is small, it has a large backlit LCD.
- A new addition to the clamp lineup is a small-diameter current clamp (model 96033, capable of measurements in the range of 5–50 A) for measurements in tight spots and locations where many wires are jumbled together.

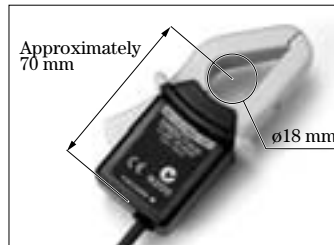

Current clamp (96033)



Magnetic case (93023)

Measurements

- The CW120 Series can be used for voltage measurements up to 495 V.
- A variety of connection types are supported, from single-phase 2-wire to three-phase 4-wire (CW120: three-phase 3-wire model; CW121: three-phase 4-wire model).
- Continuous measurement integration (accurate measurements can be obtained even if there are large load fluctuations)
- Plus/minus signs are shown for reactive power and power factor.
- The data saving interval can be set in the range of one second to one hour.

Parameters setting tool (name: Toolbox)

The setting software allows you to set CW120 Series measurement conditions through a PC and save measurement data on a PC when the unit is connected to the PC through RS-232 or RS-485 port.

● Measurement conditions setting function

This function makes it easy to set basic functions needed for measurement, such as start/stop time and date, wiring method, clamp type, voltage, and current range etc.

● File transfer function

The data file stored in CF pack can be transferred to PC. Microsoft Excel can read transferred data file.

* Toolbox is included as a standard feature (on two floppy disks).



Setting screen

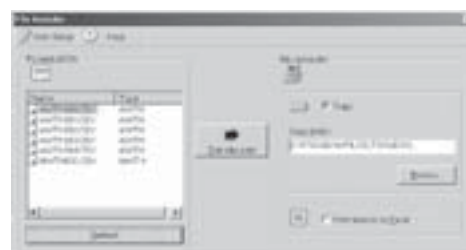

File transfer screen

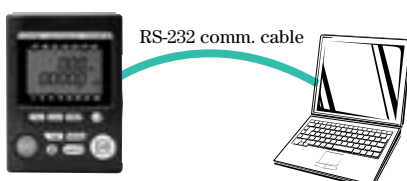

Microsoft, Windows, and Excel are trademarks or registered trademarks of Microsoft Corporation, the United States.

Advanced data management and communication

Data management and communication

- ① You can connect CW120 to a PC through dedicated RS-232 cable.
- ② A printer (sold separately) can be connected through RS-232 cable to print measurement data.
- ③ If you have a media reader connected to your PC or card slot in notebook PC, measurement data and settings can be uploaded directly to a PC from CF* pack.

Wiring Method	Memory	Interval Time	Stored Period
3φ4W	16MB	1 Second	Approx 24 Hours
3φ4W	16MB	1 Minute	Approx 2 Months
3φ4W	16MB	10 Minutes	More than 1 Year
3φ4W	32MB	1 Second	Approx 40 Hours
3φ4W	32MB	10 Minutes	Approx 4 Months

* Compact Flash cards with memory capacity up to 128 MB may be used (recommended brand: SanDisk).

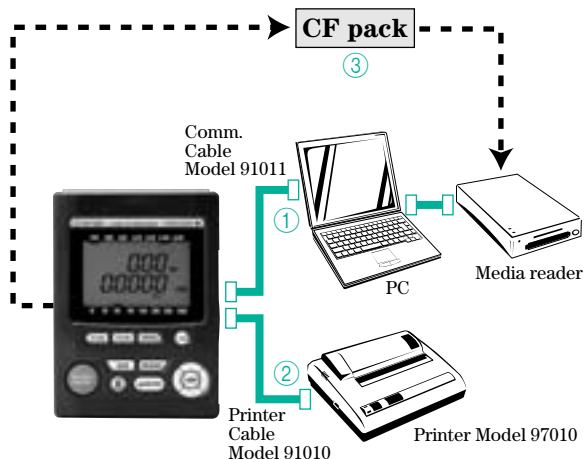

Network Communication

CW120 In addition to proprietary communication also supports, MODBUS, PC-link and Power Monitor protocols. PC-link is a protocol for Yokogawa's Temperature controllers and PLCs. Power Monitor protocol is a protocol for Yokogawa's Power Monitors. (PR201)

Data Management by DAQLOGGER*

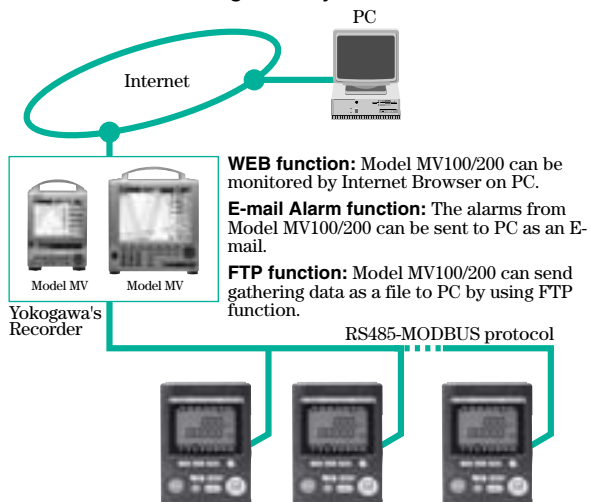

* DAQLOGGER is Yokogawa's communication software for Windows 95/98/NT4.0/2000/XP

Remote monitoring

The RS-485 allows multiple use to be connected for remote monitoring.

* RS-485/RS-232 converter is required to connect the CW120/CW121-m-2 (RS-485 communication spec) to the RS-232 port on your PC. Recommended brand and model: Yokogawa's RS-232/RS-485 Converter Model ML1.

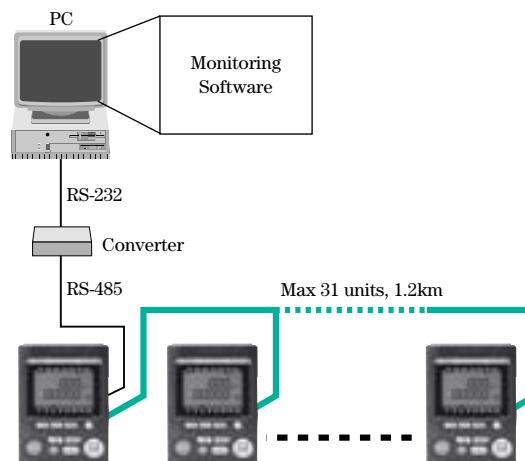

Specifications

Inputs

Parameter	Voltage (V)	Current (A)
Input type	Resistive potential division	Clamp detection
Rated value (range)	150/300/450 V	Clamp 96033: 5/10/20/50 A Clamp 96030: 20/50/100/200 A Clamp 96031: 50/100/200/500 A Clamp 96032: 200/500/1000 A
Wiring	CW120	Single-phase 2-wire, single-phase 3-wire, three-phase 3-wire
	CW121	Single-phase 2-wire, single-phase 3-wire, three-phase 3-wire, three-phase 4-wire
Input resistance	CW120	Approximately 1.5 MΩ
	CW121	Approximately 1.3 MΩ
Maximum allowed input	495 Vrms	Clamp 96033: 130 Arms Clamp 96030: 250 Arms Clamp 96031: 625 Arms Clamp 96032: 1000 Arms
A/D converter	Voltage/current input simultaneous conversion, 12-bit resolution	

Measurement Input functions

Parameter	Voltage	Current/active power
Method	Digital sampling	
Frequency range	45-65 Hz (reciprocal system), detected from V1	
Crest factor	150/300 V range	Rated input: 2
	450 V range	Rated input: 1.56
Active input range	10-110% of each range	
	Rated input: 2	Rated input: 3
Display range	Lower limit	0.4% of each range
	Upper limit	130% of each range, except 110% for 450 V range
Temperature coefficient	±0.05% rmg/°C	
Display updating interval	Approximately one second	

Instantaneous Value Measurement

- Measurement parameters: Voltage rms (V), current rms (A), active power (W), frequency (Hz)
- Measurement accuracy (at power factor 1, including clamp)
 - Voltage: ±(0.3% rdg + 0.2% rng)
 - Current/active power: ±(0.8% rdg + 0.4% rng) when using clamps 96030, 96031, and 96033
- Frequency: ±(1.2% rdg + 0.8% rng) when using clamp 96032
- Computation parameters: ±(0.1% rdg + 1% dgt)
- Computation accuracy: Reactive power (Var), power factor (value calculated from measurement) ±1 dgt
- Power factor influence: ±1.0% mg cosφ = ±0.5 (relative to power factor 1) when using clamp 96030
- ±2.0% mg cosφ = ±0.5 (relative to power factor 1) when using clamps 96031, 96032, and 96033
- Reactive factor influence: ±1.0% mg sinφ = ±0.5 (relative to reactive factor 1) when using clamp 96030
- ±2.0% mg sinφ = ±0.5 (relative to reactive factor 1) when using clamps 96031, 96032, and 96033

Equations

- Voltage rms: $V_{rms} = \sqrt{\frac{1}{T} \int_0^T v(t)^2 dt} = \sqrt{\frac{1}{T} \sum_{i=0}^T v(t)^2}$
 - Current rms: $I_{rms} = \sqrt{\frac{1}{T} \int_0^T i(t)^2 dt} = \sqrt{\frac{1}{T} \sum_{i=0}^T i(t)^2}$
 - Active power: $P = \frac{1}{T} \int_0^T v(t) \times i(t) dt = \frac{1}{T} \sum_{i=0}^T v(t) \times i(t)$
 - Single-phase 3-wire, three-phase 3-wire: $\sum P = P1 + P2$
 - Three-phase 4-wire: $\sum P = P1 + P2 + P3$
- v(t), i(t): Input signals
T: One period for input signal

Reactive power and power factor

	Reactive power (Note 2)	Apparent power	Power factor (Note 2)
Single-phase 2-wire	$Q_i = \sqrt{((VA)^2 - P^2)}$	$VA = V \times A$	P/VA
Single-phase 3-wire	$Q_i = \sqrt{((VA_i)^2 - P_i^2)}$ i=1, 2 $\sum Q = Q1 + Q2$	$VA_i = V_i \times A_i$ i=1, 2 $\sum VA = VA1 + VA2$	
Three-phase 3-wire (Note 3)	$Q_i = \sqrt{((VA_i)^2 - P_i^2)}$ i=1, 2 $\sum Q = Q1 + Q2$	$VA_i = V_i \times A_i$ i=1, 2 $\sum VA = \sqrt{3} / 2 (VA1 + VA2)$	$\sum P / \sum VA$
Three-phase 4-wire (Note 3)	$Q_i = \sqrt{((VA_i)^2 - P_i^2)}$ i=1, 2, 3 $\sum Q = Q1 + Q2 + Q3$	$VA_i = V_i \times A_i$ i=1, 2, 3 $\sum VA = VA1 + VA2 + VA3$	
Computation range	Rated value depends on V and A ranges.		-1 ~ +1
Display resolution	Same as for active power.		±1.000

Note 1: In the case of distorted waves, there may be differences from other measuring instruments that are based on different measurement principles.

Note 2: The polarity of each phase determined by the reactive power meter method is multiplied and the polarity is displayed.

Note 3: In the case of three-phase 3-wire and unbalanced inputs, there may be differences from other measuring instruments that are based on different measurement principles, or wiring.

Electric Energy Measurement

- Measured parameters: Active electric energy, regenerative electric energy (regenerative electric energy is not displayed on the screen; it is merely saved)
- Measurement accuracy: Active power measurement accuracy ±1 dgt (with standard settings)
- Integration function settings
 - Start/stop settings: Manual, timer, external trigger (control)
 - Output intervals: 1/2/5/10/15/30 seconds; 1/2/5/10/15/30 minutes; 1 hour
- Displayed digits: This is set automatically based on the rated power, and the minimum resolution can be set

Saving items

- Saving items: Voltage, current, active power, reactive power, power factor, frequency, active electric energy, regenerative electric energy

Display Functions

- Display screen: Backlit segmented LCD
- Maximum number of displayed digits
 - Electric energy: 6 digits
 - Other parameters: 4 digits
- Range makeup: (rated values)

		Clamp 96032							
		Clamp 96031				Clamp 96030			
		Clamp 96033							
Voltage	Wiring	5.000 A	10.00 A	20.00 A	50.00 A	100.0 A	200.0 A	500.0 A	1.000 kA
150.0V	1φ2W	750.0 W	1.500 kW	3.000 kW	7.500 kW	15.00 kW	30.00 kW	75.00 kW	150.0 kW
	1φ3W	1.500 kW	3.000 kW	6.000 kW	15.00 kW	30.00 kW	60.00 kW	150.0 kW	300.0 kW
	3φ3W	1.500 kW	3.000 kW	6.000 kW	15.00 kW	30.00 kW	60.00 kW	150.0 kW	300.0 kW
	3φ4W	2.250 kW	4.500 kW	9.000 kW	22.50 kW	45.00 kW	90.00 kW	225.0 kW	450.0 kW
300.0V	1φ2W	1.500 kW	3.000 kW	6.000 kW	15.00 kW	30.00 kW	60.00 kW	150.0 kW	300.0 kW
	1φ3W	3.000 kW	6.000 kW	12.00 kW	30.00 kW	60.00 kW	120.0 kW	300.0 kW	600.0 kW
	3φ3W	3.000 kW	6.000 kW	12.00 kW	30.00 kW	60.00 kW	120.0 kW	300.0 kW	600.0 kW
	3φ4W	4.500 kW	9.000 kW	18.00 kW	45.00 kW	90.00 kW	180.0 kW	450.0 kW	900.0 kW
450.0V	1φ2W	2.250 kW	4.500 kW	9.000 kW	22.50 kW	45.00 kW	90.00 kW	225.0 kW	450.0 kW
	1φ3W	4.500 kW	9.000 kW	18.00 kW	45.00 kW	90.00 kW	180.0 kW	450.0 kW	900.0 kW
	3φ3W	4.500 kW	9.000 kW	18.00 kW	45.00 kW	90.00 kW	180.0 kW	450.0 kW	900.0 kW
	3φ4W	6.750 kW	13.50 kW	27.00 kW	67.50 kW	135.0 kW	270.0 kW	675.0 kW	1.350 MW

■ Communication Functions

- Electrical specifications: Conforms to EIA RS-232 or EIA RS-485.
- Protocols: CW120/121 proprietary protocol, Power Monitor protocol (Standard protocol used for YOKOGAWA M&C's Power Monitor)
PC link communication (Standard protocol used for YOKOGAWA M&C's Temperature Controllers)
MODBUS communication (ASCII or RTU)
- Synchronization system: Start stop synchronization
- Baud rates: 1200, 2400, 4800, 9600, 19200, 38400 bps

■ PC card interface

- Slot: PC card slot TYPE II
- Compatible card: ATA flash memory card
- Function specifications: Saving measurement data, saving and reading settings data

■ Faulty Wiring Checking Functions

- Check details:
 - Presence/absence of power input; check for frequency measurement range; voltage phase sequence;
 - presence/absence of power input; whether current clamp is reverse-connected

■ Scaling Function

The VT ratio and CT ratio can be set.

- Settings ranges

VT ratio: 1-10,000
CT ratio: 1-10,000 (in increments of 0.01)

■ External Control I/O (for RS-232 only; not provided for RS-485)

These input and output can be used as signals for starting and stopping integrating measurement.

- Control input: TTL level or contact
- Control output: TTL level

■ Other Functions

Clock (typical precision: ± 100 ppm), key lock, system reset

■ General Specifications

- Environmental requirements: Indoor usage at an altitude of 2000 meters or less.
- Usage temperature and humidity ranges:

0-50°C, 5-85% RH (no condensation)
0-40°C, 5-85% RH (no condensation) for UL, C-UL
- Storage temperature and humidity ranges:

-20-60°C, 90% RH (no condensation)

- Insulating resistance:
 - 500 V DC, 50 MW or greater
 - Between voltage input terminals and case
 - Between voltage input terminals and current input terminals, communication terminals, and control I/O terminals
 - Between power line and case
 - Between power line and current input terminals, communication terminals, and control I/O terminals
- Insulating withstand voltage:
 - 5550 V AC for one minute
 - Between voltage input terminals and case
 - 3320 V AC for one minute
 - Between voltage input terminals and current input terminals, communication terminals, and control I/O terminals
 - 2300 V AC for one minute
 - Between power line and case
 - Between power line and current input terminals, communication terminals, and control I/O terminals
- Power supply: 100-240 V AC $\pm 10\%$, 50/60 Hz
- Consumed power: 8 VA maximum
- External magnetic field effects: Within accuracy levels at 400 A/m
- External dimensions: Approximately 117 × 161 × 51 mm (W × H × D)
- Weight: Approximately 0.6 kg
- Terminals:

Voltage input	CW120: 3 terminals	Banana terminals (safety terminals)
	CW121: 4 terminals	Banana terminals (safety terminals)
Current terminals	CW120: 2 pairs	Banana terminals (safety terminals)
(H/L)	CW121: 3 pairs	Banana terminals (safety terminals)
External control I/O	3 terminals (H/L/H)	Screwless terminals
terminals RS-485	4 terminals (+/-SG/TM)	M3 screw terminals
- Connectors:
 - RS-232: Mini DIN 8-pin
 - AC power supply: 2-pin
- Accessories:
 - Voltage input probes: 3 for CW120, 4 for CW121
 - Power cord, user's manual, operation guide, Toolbox (setting software)
- Safety standards:
 - Compliant with EN61010-1, EN61010-2-031, UL3111-1 First Edition, CAN C22.2 No. 1010.1-92
 - Voltage input line
 - Measurement (Overvoltage) category III (Max. input voltage : 600 Vrms)
 - Power line
 - Installation category II (Max. input voltage : 264 Vrms)
 - Pollution degree 2
- EMC (emission):
 - Compliant with EN55011, Group1, ClassA; EN61326; EN61000-3-2; EN61000-3-3
- EMC (immunity):
 - Compliant with EN61326

CW240 Model and Suffix Code

Model name and suffix code

Model (Part No.)	Suffix code	Option code	Description
CW240			
	-D		Power Cord (UL/CSA Standard)
	-F		Power Cord (VDE Standard)
	-H		Power Cord (GB Standard)
	-R		Power Cord (SAA Standard)
	-S		Power Cord (BS Standard)
		/DA	Analog input/output function
		/C1	Clamp-on Probe for 20/200A (2pcs/set)
		/C2	Clamp-on Probe for 20/200A (4pcs/set)
		/C3	Clamp-on Probe for 500A (2pcs/set)
		/C4	Clamp-on Probe for 500A (4pcs/set)
		/C5	Clamp-on Probe for 700A (2pcs/set)
		/C6	Clamp-on Probe for 700A (4pcs/set)
		/C7	Clamp-on Probe for 50A (2pcs/set)
		/C8	Clamp-on Probe for 50A (4pcs/set)
		/C9	Clamp-on Probe for 2A (2pcs/set)
		/C10	Clamp-on Probe for 2A (4pcs/set)
		/C11	Clamp-on Probe for 3000A (2pcs/set)
		/C12	Clamp-on Probe for 3000A (4pcs/set)
		/C13	Clamp-on Probe for 3000A(Flexible Type) (2pcs/set)
		/C14	Clamp-on Probe for 3000A(Flexible Type) (4pcs/set)
		/PM1	NiMH battery pack(94004) and carrying case(93020)

Standard accessories comes with main unit

91007 Voltage probes, AC adapter x1, AA size alkaline battery x6, ToolBox240(CD-ROM)x1, User's Manual x1/CD-ROM version x1, Quick Manual x1/CD-ROM version x1, Communication function manual(CD-ROM) x1

Accessories

Carrying case



93020

Protective Cover



91022

CW240 main unit can be packed in the carrying case with accessories like current clamps and voltage probes, without disconnecting them from the main unit. It also holds the other accessories.

To prevent error connection of clamp probes.

Name	Model No.	Description
Voltage probes (4 pcs/set)	91007	
NiMH battery pack	94004	
Memory Card (256MB)	97034	256MB CF with PC Card Adapter
Memory Card (512MB)	97035	512MB CF with PC Card Adapter
Printer	97010	
AC adapter (for printer, Europe)	94006	Power Supply 200-240 VAC
AC adapter (for printer, USA)	94007	Power Supply 100-120 VAC
Thermal paper for printer (10 rolls)	97080	
AC adapter for 96035	A1022UP	For AC 120V
	B9108WB	For AC 220-240V
CW viewer	AP240E	

CW120 Models and Suffix code

Model name and suffix code

Model (Part No.)	Suffix code	Option code	Description
CW120			Three-phase 3-wire
CW121			Three-phase 4-wire
Power cord	-D		AC power cord (UL/CSA Standard)
	-F		AC power cord (VDE Standard)
	-H		AC power cord (GB Standard)
	-R		AC power cord (SAA Standard)
	-S		AC power cord (BS Standard)
Communication	-1		RS-232 communication interface
	-2		RS-485 communication interface
		/C1	Two 200 A current clamp-on probes (96030)
		/C2	Three 200 A current clamp-on probes (96030)
		/C3	Two 500 A current clamp-on probes (96031)
		/C4	Three 500 A current clamp-on probes (96031)
		/C5	Two 700 A current clamp-on probes (96032)
		/C6	Three 700 A current clamp-on probes (96032)
		/C7	Two 50 A current clamp-on probes (96033)
		/C8	Three 50 A current clamp-on probes (96033)

Accessories

Carrying case



93022

Main unit case



93023

Portable case



93024

CW120 main unit can be packed in the carrying case with accessories like the current clamps and voltage probes. It also holds the other accessories.

Includes magnet and stand

Power cable



98030

Printer



97010

This cable supplies power from a measurement circuit, length 1.5m
*Not applied to CE and UL

Accessories supplied at no extra cost

Product Name	Part No.	Qty
1. Power cord		1
2. Voltage probes (for CW 120)	91018	3
Voltage probes (for CW 121)	91007	4
3. User's Manual	IM CW120-E	1
4. Operation Guide	IM CW-120P-E	1

Name	Model No.	Description
Voltage probe	91007	Four per set
Voltage probe	91018	Three per set
Communication cable	91011	RS232 communication cable for PC (9-pin)
Printer cable	91010	RS232 printer cable, length 1.5 m
Memory Card (256MB)	97034	256MB CF with PC Card Adapter
Memory Card (512MB)	97035	512MB CF with PC Card Adapter
Printer	97010	Includes one roll of thermal paper and one battery pack
AC adapter (for printer, Europe)	94006	Power Supply 200-240 VAC
AC adapter (for printer, USA)	94007	Power Supply 100-120 VAC
Printer thermal paper	97080	10 rolls
AC adapter for 96035	A1022UP	For AC 120V
	B9108WB	For AC 220-240V
CW viewer	AP240E	

Effective power supply quality and power saving management for PCs

CWViewer

Data Analysis Program for CW240/CW12x

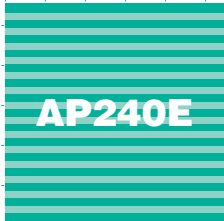

AP240E report creation in line with your objectives.

Powerful & Accurate measurement with the CW240

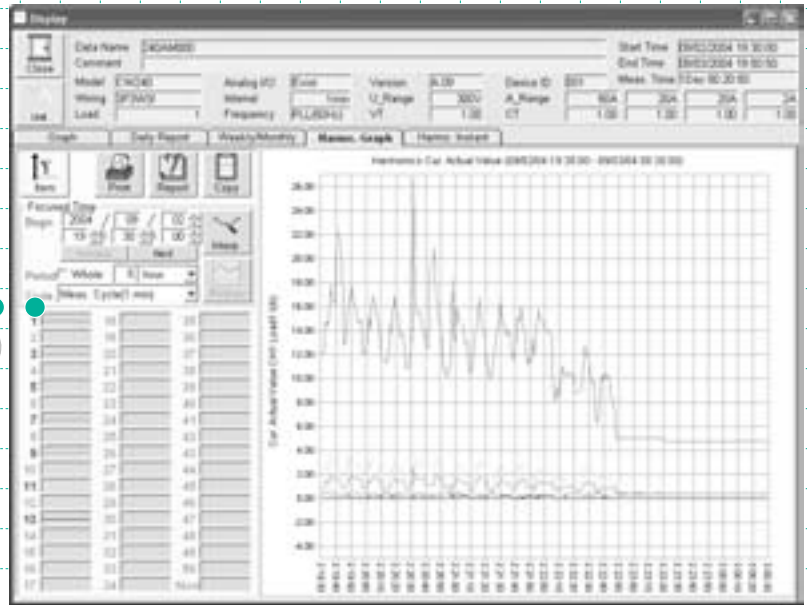
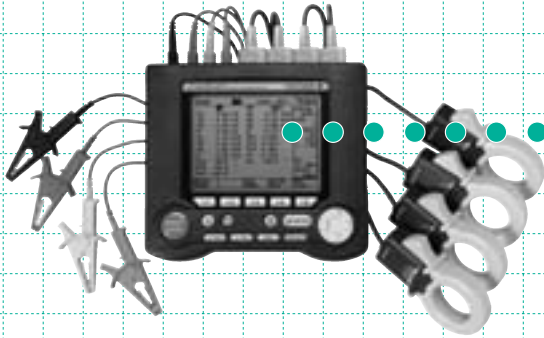

Increased quality and effectiveness of report creation

CW Viewer AP240E is data analyzing software for the CW240 Clamp-on Power Meter. Making full use of the rich measuring functions of the CW240, this efficiently manages the large amounts of measurement data that are required in order to implement power quality management, energy management, and power saving measures. Furthermore, the quality and efficiency of report creation has been improved in order that reports to meet certain purposes can be easily created.

Report creation in line with objectives

- Graph Display
- Daily Report Display, Weekly / Monthly Report Display
- Harmonic Graph Display
- Harmonics Instant Value Display
- Waveform Data Display
- Voltage Change Display

Graph

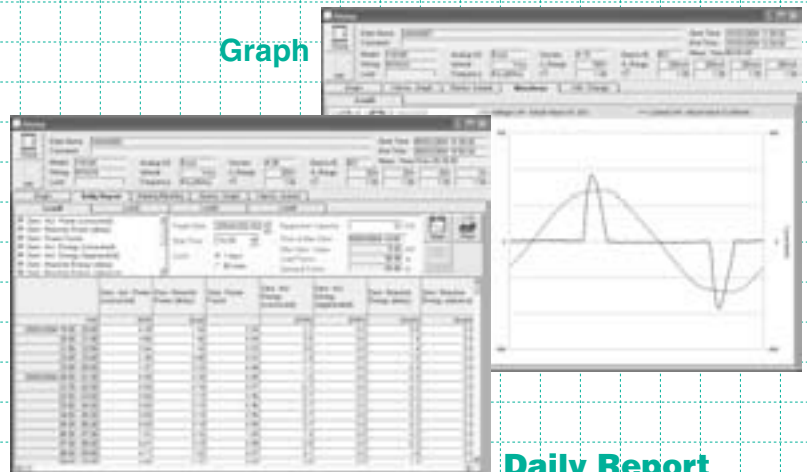

Daily Report

Power quality and power saving management data measured with the CW240

AP240E report creation in line with your objectives

Increased quality and effectiveness of report creation

Bulk Data Management

In order to edit measurement data to create reports that meet objectives, it is necessary to sort the required elements from a broad range of measurement data, and to set both the parameters for display, and items to display. CW Viewer AP240E carries out bulk management of data by registering measurement data and display parameters. Easy data registration, deletion, reference, and analysis means that the program is easy to use immediately, even for beginners.

●Bulk Management of Large Quantities of Measurement Data

Using the AP240E, it is easy to register a large amount of data measured with CW240 in the database, for integrated handling.

- ① At the time of data registration, only the target files are displayed, and detailed information can be confirmed by selecting these files.
- ② Measurement data can be searched by measurement date or group name.
- ③ Automatically links to measurement data such as that for waveforms and voltage changes.
- ④ Group names and comments can be added and registered.

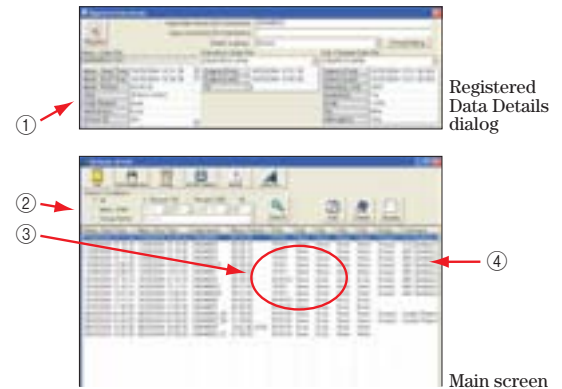

●Fast Reproduction of Past Reports

CW Viewer AP240E links display parameters for graphs and records with measurement data, and saves this in the database, which means that reports that have been created in the past can be swiftly recreated in the same format.

Simple Report Creation

Select measurement data, and click the Data Display button to edit reports. Settings of display items is easy, and items such as graphs and daily reports are easy to create.

Simple Operation

Clear Display

●Pick out target elements from large amounts of data.

Items that can be selected when setting display items are displayed in a list, which means that measurement data items that are required for carrying out power management and power quality management can be efficiently selected to meet objectives.

- ① Up to a maximum of 8 items can be set for both the left and right axes.
- ② Display items, units, and scale, etc. can be selected from the list.
- ③ Desired maximum and minimum values for the graph scale can be set. Additionally, the Automatic Settings button can be used to set optimal values.
- ④ This is also convenient for comparisons with power reduction targets, by setting standard values.

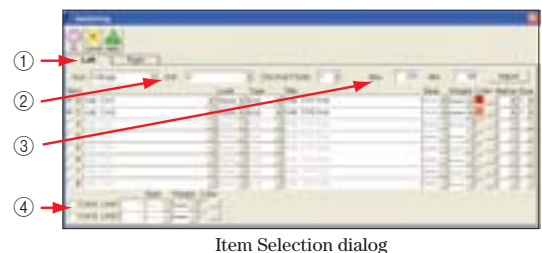

●Easy Setting of Focus Times

Setting the start and period of the focus times enables setting of a range of part (or all) of the measurement data.

- ① The display start time can be specified from the range of existing measurement data.
- ② The specified display range can be moved easily using these buttons.
- ③ The graph display period (the whole period or a desired period) can be specified.
- ④ A desired range (more than the measurement cycle) can be specified.

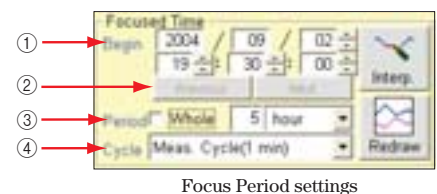

Variety of Presentations in Line with Objectives

Report formats that can be selected as a result of the types of measurement data are displayed on tabs. Report formats in line with objectives can be easily selected with tabs from a variety of report presentations.

● Selection of Report Formats with Tabs

Report formats such as graph display, daily report display, harmonics graph and voltage change can be easily switched by selection with tabs.

Superimposed Display of Multiple Waveforms

A channel, system, and type can be selected for each measurement item such as power, voltage, and current, and up to 8 items can be simultaneously displayed on the graph for each of the left and right vertical axes (a total of 16 items). This enables the comparative display per channel and system of multiple data items.

● Easy-to-see Graph Display

Graph display can be changed (line type, line thickness, and line color, markers, etc.) in line with objectives, and multiple measurement data can be displayed on the report in an easy to see manner.

● Harmonics Data Analysis

Harmonics graphs are displayed by selecting the desired degree from amongst 50. Harmonics trend graphs and harmonics instant value graphs can be selected with tabs, and in the harmonics instant value tab, all harmonics levels, harmonics content ratios, and phase differences can be displayed. Vector display of power phase differences is also possible.

● Waveform Data Display

Displays as a graph waveform data (maximum of 7 for each of four systems) measured with the CW240. Irregularities in voltage and current waveforms for each phase can be viewed at a glance, making for effective management of electrical power quality (current situation and confirmation of measures taken).

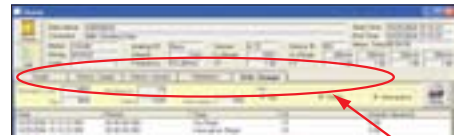

Tab Selection



Graph Display



Harmonics Trend Display



Harmonics Instant Value Display



Power Phase Difference Vector Diagram Display

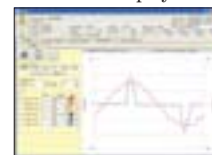

Waveform Display

One-Touch Selection of Daily and Weekly Reports

● Daily Report Display

Demand measurement values for power consumption are displayed in time units (30 minutes or 1 hour) as daily reports, simply by selecting the desired demand measurement items. Furthermore, load and demand ratio calculations are carried out automatically by setting capacitance values for facilities.

● Weekly and Monthly Report Display

Demand measurement values for power consumption in 1 day units are displayed as weekly and monthly reports. Load and demand ratio calculations are carried out automatically in the same way as with daily reports.

● Voltage Change Display

Displays in a list voltage drops, rises, and momentary power interruption detection data and detection time. This enables confirmation of the start, end, and period of voltage changes.

● Record Display

When the graph display, harmonics trend display, and harmonics instant value display tabs have been selected, numerical data for the displayed graph range can be displayed as a record.



Daily Report Display



Voltage Change Display

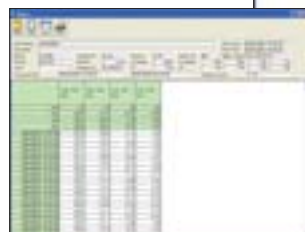

Records Display

Report Creation Customization Functions

●Graph and Record Printing

Print graphs and records by using the Print buttons on the graph display screen and records screen. Additionally, when printing, the preview screen will allow confirmation of output.



Print Preview

●Selectable Printer Type

Printer configuration is possible in order that either color or monochrome are printed correctly.

AP240E Analysis Data can be Further Edited in MS Excel and Word

●Graph Copy

The portion of the graph on the displayed screen can be copied to the clipboard by using the Graph Copy button on the graph screen. This enables graph images that are created in CW Viewer AP240E to be pasted into Excel or Word documents. Power phase difference vector diagrams and waveform data are also handled in the same way.

Pasting Records Pasting Graphs

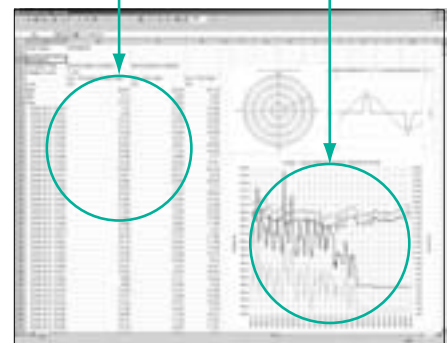

Example of Copying Graphs and Records

●Record Copy

By using the Record Copy button in the same way as with graphs, record data can be copied to the clipboard. Record data is copied as text data.

●Saving Record Data as CSV Format Files

The range of data displayed on the daily report, monthly report, and record screens can be saved as CSV format files. CSV files can be used in spreadsheet software; this is convenient for secondary analysis of measurement data, and creation of original reports.

Useful Functions

●Analog Input Data

Scaling for analog input data settings, and unit settings can be carried out. This enables comparison of measurement data such as temperature and lighting density with data such as used energy.



Scaling Settings

●Voltage Unbalance Ratio Display

Automatically measures voltage unbalance ratios when CH1 ~ CH3 voltage is measured, and can display as a graph in the same way as with other measurement data items.

●Default Settings

Frequently used unit settings, graph display parameter settings, and group name settings, etc. can be registered as defaults in advance.



Default Settings

●Display Settings / Measurement Parameter Display

Settings parameters and measurement intervals, etc. at the time of measurement are displayed on the top of the tabs on the data display screen, enabling constant confirmation by selecting tabs even if the report format is changed.



Measurement Parameter Display

AP240E Specifications

Data Management

- Display of measurement parameters when measurement data is registered.
- Registration in the database of measurement date, measurement parameters, group names, and comments added to measurement data possible.
- Bulk management of data such as harmonics data, waveform data, and voltage change data.
- Editing of data names, comments, and group names possible.
- Searching by measurement dates / periods, and group names possible.
- Saving of settings information at the time the report was displayed, and that corresponds to data.
- Setting of defaults for a range of settings data possible.

Data Display Selection

- Always display measurement parameters on the data display screen.
- Selection by the use of tabs to select report displays (graph display, daily report display, weekly / monthly report display, harmonic graph display, harmonics instant value display, waveform data display, voltage change display) possible.

Graph Display

- Graph display of up to 8 items on each of the left and right axes possible.
- Selection of display items an ordered list possible.
- Settings of units, decimal points, minimum values, and maximum values, as well as automatic adjustment for each of the left and right axes possible.
- Graph customization (line type, line thickness marker, color) possible.
- Setting of the graph display period (focused time, period, measurement cycle) possible.
- Movement of the graph display period possible.
- Graph interpolation of non-measured segments possible.

Daily Report Display, Weekly / Monthly Report Display

- Displays the daily report, and weekly / monthly report tabs where there is demand measurement data.
- Displays selected demand measurement values per time (or date).
- Selection of display intervals for daily report display (1 hour / 30 minutes) possible.
- Can set the equipment capacity, and automatically calculate load ratios and demand ratios.

Harmonic Graph Display

- Displays the harmonics graph tab where there is harmonics measurement data.
- Selection of degree data up to a maximum of 50 degrees possible.

Harmonics Instant Value Display

- Displays the harmonics graph tab when there is harmonics measurement data.
- Selection of degrees of up to 50 possible.
- Display of power phase difference vector diagrams possible.

Waveform Data Display

- Displays the waveform data tab when there is waveform data.
- Display of selected waveform data.

Voltage Change Display

- Displays the voltage change data tab when there is voltage change detection data.
- Displays voltage change data per detection time.
- Selection of display items (voltage dip, voltage swell, detected momentary power interruptions) possible.

Package contents

Contents	AP240E installation CD	1
	User registration card	1

Common Accessories for CW120/121 and CW240

Item	96030 Clamp-on Current Probe	96031 Clamp-on Current Probe	96032 Clamp-on Current Probe	96033 Clamp-on Current Probe	96036 Clamp-on Current Probe	
Measuring range	0-200 Arms AC (300 Apk)	0-500 Arms AC (750 Apk)	0-700 Arms AC (990 Apk)	0-50 Arms AC	0-2Arms AC (20Apk)	
Output voltage	0-0.5 Vrms AC (2.5 mV/A)	0-0.5 Vrms AC (1 mV/A)	1000 Arms (1414 Apk) for 5 minutes	0-0.5 Vrms AC (10 mV/A)	0-0mVrms AC (25mV/A)	
Accuracy	Amplitude	$\pm 1.5\%$ rdg ± 0.4 mV (20 Hz to 45 Hz) $\pm 0.5\%$ rdg ± 0.1 mV (45 Hz to 66 Hz) $\pm 0.8\%$ rdg ± 0.2 mV (66 Hz to 1 kHz) $\pm 2.0\%$ rdg ± 0.4 mV (1 kHz to 20 kHz)	$\pm 1.5\%$ rdg ± 0.4 mV (20 Hz to 45 Hz) $\pm 0.5\%$ rdg ± 0.1 mV (45 Hz to 66 Hz) $\pm 0.8\%$ rdg ± 0.2 mV (66 Hz to 1 kHz)	0-0.25 Vrms AC (0.25 mV/A) $\pm 1.0\%$ rdg ± 0.2 mV (45 Hz to 66 Hz)	$\pm 1.0\%$ rdg ± 0.3 mV (20 Hz to 45 Hz) $\pm 0.5\%$ rdg ± 0.1 mV (45 Hz to 66 Hz) $\pm 0.8\%$ rdg ± 0.2 mV (66 Hz to 1 kHz) $\pm 1.0\%$ rdg ± 0.3 mV (1 kHz to 5 kHz) $\pm 3\%$ rdg ± 0.4 mV (5 kHz to 20 kHz)	$\pm 1.5\%$ rdg ± 0.04 mV (20Hz-45Hz) $\pm 0.5\%$ rdg ± 0.01 mV (45Hz-66Hz) $\pm 0.8\%$ rdg ± 0.02 mV (66Hz-1kHz) $\pm 2\%$ rdg ± 0.04 mV (1kHz-5kHz)
	Phase	$\pm 0.5^\circ$ (45 Hz to 1 kHz)	$\pm 1.0^\circ$ (45 Hz to 1 kHz)	$\pm 1.0^\circ$ (50 A or more, 45 Hz to 66 Hz)	$\pm 1.0^\circ$ (45 Hz to 1 kHz)	$\pm 2^\circ$ (45Hz-3.5kHz)
(for temperature of 23°C $\pm 5^\circ$ C, relative humidity of 35-75%, and sine wave input)						
Output impedance	Approx. 6 Ω	Approx. 2.4 Ω	Approx. 100 Ω (max.)	Approx. 18 Ω	Approx. 70 Ω	
External magnetic field effects	0.1 A equivalent or less (at 400 A/m, 50/60 Hz)	0.2 A equivalent or less (at 400 A/m, 50/60 Hz)	0.5 A equivalent or less (at 400 A/m, 50/60 Hz)	0.1 A equivalent or less (at 400 A/m, 50/60 Hz)	2mA equivalent or less (at 400A/m, 50/60Hz)	
Conductor position effects	$\pm 0.5\%$ (at 20-200 A, 45 Hz to 1 kHz)	$\pm 0.5\%$ (at 50-500 A, 45 Hz to 1 kHz)	$\pm 0.5\%$ (at 200-1000 A, 45 Hz to 66 Hz)	$\pm 0.5\%$ (at 1-50 A, 45 Hz to 1 kHz)	$\pm 0.5\%$ (at 0.2-2A, 45Hz-1kHz)	
Operating circuit voltage	600 Vrms AC max.			300 Vrms AC max.	50Vrms AC max.	
External dimensions	Approx. 73 (W) \times 130 (H) \times 30 (D) mm		Approx. 100 (W) \times 172.5 (H) \times 32 (D) mm	Approx. 52 (W) \times 106 (H) \times 25 (D) mm (excluding protrusions)	Approx. 70(W) \times 120(H) \times 25(D)mm	
Weight	Approx. 300 g		Approx. 500 g	Approx. 220 g	Approx. 300g	
Output cable length	Approx. 3 meters					

External Dimensions

Item	96034 Clamp-on Current Probe			96035 Clamp-on Current Probe		
	1000 A	2000 A	3000 A	3000 A	300 A	
Measuring range	0-1000 Arms AC	0-2000 Arms AC	0-3000 Arms AC	0-3000 Arms AC	0-300 Arms AC	
Output voltage	0-0.5 Vrms AC (0.5 mV/A)	0-0.5 Vrms AC (0.25 mV/A)	0-0.5 Vrms AC (0.1667 mV/A)	0-0.5 Vrms AC (0.1667 mV/A)	0-0.5 Vrms AC (1.667 mV/A)	
Accuracy (for temperature of 23°C $\pm 5^\circ$ C, relative humidity of 20-70% and sine wave input)	Amplitude	$\pm 1\%$ rdg ± 0.045 mV (1-20 A) $\pm 1\%$ rdg (20-1200 A)	$\pm 1\%$ rdg ± 0.0225 mV (1-20 A) $\pm 1\%$ rdg (20-2400 A)	$\pm 1\%$ rdg ± 0.015 mV (1-20 A) $\pm 1\%$ rdg (20-3600 A)	$\pm 1\%$ rdg (5-3000 A, 45 Hz to 66 Hz) $\pm 3\%$ rdg (100 A, 10 Hz to 10 kHz)	$\pm 1\%$ rdg (5-300 A, 45 Hz to 66 Hz) $\pm 5\%$ rdg (100 A, 10 Hz to 10 kHz)
	Phase	Not specified (1-20 A) $\pm 1.0^\circ$ (20-200 A) $\pm 0.5^\circ$ (200-1200 A)	Not specified (1-20 A) $\pm 1.0^\circ$ (20-200 A) $\pm 0.5^\circ$ (200-2400 A)	Not specified (1-20 A) $\pm 1.0^\circ$ (20-200 A) $\pm 0.5^\circ$ (200-3600 A)	$\pm 1^\circ$ (5-3000 A, 45 Hz to 66 Hz) $\pm 4^\circ$ (200 A, 40 Hz to 1 kHz)	$\pm 1^\circ$ (5-300 A, 45 Hz to 66 Hz) $\pm 7^\circ$ (200 A, 40 Hz to 1 kHz)
Maximum allowable current (600 Hz or less)	1200 Arms AC (continuous)	2400 Arms AC (continuous)	2400-2800 Arms AC (for 15 minutes) 2800-3600 Arms AC (for 10 minutes)	3600 Arms AC (10 Hz to 1 kHz)	360 Arms AC	
Output impedance	2 Ω or less			Approx. 47 Ω		
External magnetic field effects	$\pm 0.1\%$ of full scale (at 400 A/m, 50/60 Hz)					
Conductor position effects	1% ± 0.2 A or less			$\pm 2\%$ of full scale		
Operating circuit voltage	600 Vrms AC max.			Main unit: 600 Vrms AC max. Measuring unit: 1000 Vrms AC max.		
Measurable conductor diameter	$\phi 64 \times 100$ mm, five 125 \times 5 mm bus bars, or three 100 \times 10 mm bus bars			$\phi 170$ mm max.		
External dimensions	Approx. 310 (W) \times 120 (H) \times 48 (D) mm			Main unit: Approx. 140 (W) \times 64 (H) \times 28 (D) mm Measuring unit: Approx. 610 mm		
Weight	Approx. 1400 g			Main unit: Approx. 300 g (including battery and output cable) Measuring unit: Approx. 180 g		
Output cable length	Approx. 3 meters					
Output terminal	Banana plug (safety terminal)					
Power supply				9 V alkaline battery (6LF22) AC Adapter Continuous measurement: 150 hours Intermittent measurement: 10,000 times		

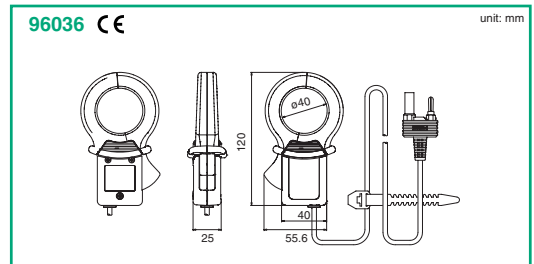
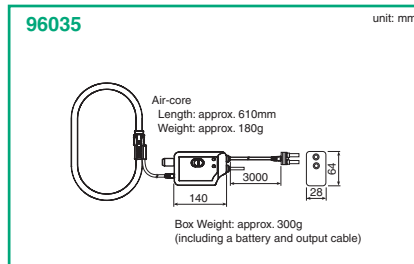
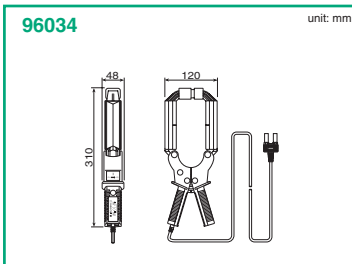
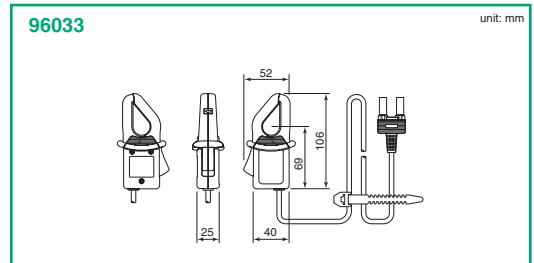
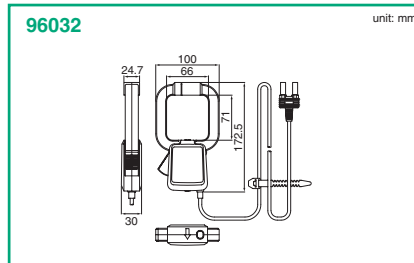
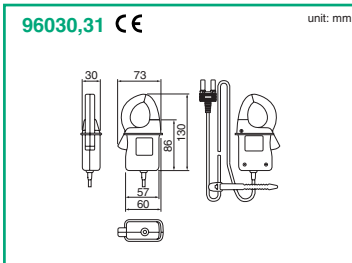

YOKOGAWA 
Yokogawa Meters & Instruments Corporation

World Wide Web site at
<http://www.yokogawa.com/MCC>

 **NOTICE**

- Before using the product, read the instruction manual carefully to ensure proper and safe operation.

YOKOGAWA METERS & INSTRUMENTS CORPORATION Tachih Bld. No.2, 6-1-3 Sakaecho, Tachikawa-shi, Tokyo, 190-8586 Japan
International Sales Dept. Phone: +81-42-534-1413 Facsimile: +81-42-534-1426

YOKOGAWA CORPORATION OF AMERICA (U.S.A.) Phone: +1-770-253-7000
YOKOGAWA EUROPE B. V. (THE NETHERLANDS) Phone: +31-334-64-1611
YOKOGAWA ENGINEERING ASIA PTE. LTD. (SINGAPORE) Phone: +65-6241-9933
YOKOGAWA AMERICA DO SUL LTDA (BRAZIL) Phone: +55-11-5681-2400
YOKOGAWA MEASURING INSTRUMENTS KOREA CORPORATION (KOREA) Phone: +82-2-551-0660
YOKOGAWA AUSTRALIA PTY. LTD. (AUSTRALIA) Phone: +61-2-8870-1100
YOKOGAWA INDIA LTD. (INDIA) Phone: +91-80-4158-6000
YOKOGAWA SHANGHAI TRADING CO., LTD. (CHINA) Phone: +86-21-6880-8107
YOKOGAWA MIDDLE EAST E.C. (BAHRAIN) Phone: +973-358100
YOKOGAWA ELECTRIC CIS LTD. (RUSSIAN FEDERATION) Phone: +7-095-737-7868

Facsimile: +1-770-251-2088
Facsimile: +31-334-64-1610
Facsimile: +65-6241-2606
Facsimile: +55-11-5681-1274/4434
Facsimile: +82-2-551-0665
Facsimile: +61-2-8870-1111
Facsimile: +91-80-2852-1441
Facsimile: +86-21-6880-4987
Facsimile: +973-336100
Facsimile: +7-095-737-7869

Represented by:

MIK-ES15